

AMERICAN STANDARD FOR NURSERY STOCK

ANSI Z60.1-2004

Approved May 12, 2004



DEDICATION

This edition of the *American Standard for Nursery Stock* is dedicated in memory of Ronnie Swaim, Gilmore Plant & Bulb Co., Inc. (NC)

Copyright 2004 by American Nursery & Landscape Association

All rights reserved. No part of this book may be reproduced or transmitted in any form or by any means, electronic or mechanical, including photocopying, recording, or by any information storage and retrieval system, without permission in writing from the publisher.

American Nursery & Landscape Association
1000 Vermont Avenue, NW, Suite 300
Washington, DC 20005
www.anla.org

ISBN 1-890148-06-7



Click on each contents listing in this pdf document to link to the page in the text.

Foreword	i	1.3.1.2 Specification	9
Container size specifications	ii	1.3.1.3 Measurement.....	9
Container class table	iii	1.3.2 Clump form and multi-stem trees.....	9
In-ground fabric bag specifications.....	iii	1.3.2.1 Definitions	9
How to use this publication	iv	1.3.2.2 Specification	10
Horticultural standards committee.....	vi	1.3.2.2.1 Clump form trees.....	10
Canvass list.....	vii	1.3.2.2.2 Multi-stem trees	10
		1.3.2.3 Caliper measurements—clump form and multi-stem trees.....	10
		1.3.2.4 Root ball sizes—shrub form, clump form and multi-stem trees.....	11
		1.3.2.4.1 Root ball diameters—shrub form trees.....	11
		1.3.2.4.2 Root ball diameters—clump form trees	11
		1.3.2.4.2 Root ball diameters—multi-stem trees	11
		1.4 Palms	12
		1.5 Bare root specifications	13
		1.5.1 Nursery grown—spread of roots.....	13
		1.5.2 Collected—spread of roots.....	14
		1.6 Root ball guidelines	15
		1.6.1 Root ball diameters—field grown trees.....	15
		1.6.2 Trunk in center of root ball.....	17
		1.6.3 Root ball depths.....	17
		1.6.4 Burlapping	18
		1.6.5 Ball-supporting devices	18
		1.6.6 Collected	18
		1.6.7 Plantation grown.....	19
		1.6.8 Field potted or field boxed	19
Section 1: Shade and Flowering Trees			
1.1 Specifications—general	1		
1.1.1 Required specifications	1		
1.1.1.1 Plant size intervals.....	1		
1.1.1.2 Methods of caliper and height measurement.....	1		
1.1.2 Optional specifications and quality designations.....	2		
1.1.2.1 Height and caliper	2		
1.1.2.2 Transplanting requirements.....	2		
1.1.2.3 Specimen or quality grade designation.....	2		
1.1.2.4 Height of branching—street trees	2		
1.1.2.5 Trees for other uses.....	3		
1.2 Types of trees.....	3		
1.2.1 Type 1 shade trees	3		
1.2.2 Type 2 shade trees	5		
1.2.3 Type 3 small upright trees	6		
1.2.4 Type 4 small spreading trees	7		
1.3 Shrub form, clump form, or multi-stem trees... 8			
1.3.1 Shrub form trees	8		
1.3.1.1 Definition	8		

1.6.9 Processed balled.....	19
1.6.10 Use of digging machines	19
1.7 Container grown specifications.....	20
1.8 Box-grown	21
1.9 In-ground fabric bag-grown.....	22

SECTION 1 FIGURES AND TABLES

Figure 1—Caliper and branching height.....	3
Figure 2—Measurement—type 2 shade trees	5
Figure 3—Type 3 small upright trees.....	6
Figure 4—Type 4 small spreading trees	7
Figure 5— Multi-stem, clump form, and shrub form trees ...	11
Figure 6—Palms.....	13
Figure 7—Measurement—field grown trees	14
Figure 8—Example: trunk in center of root ball	17
Figure 9—Measurement of root ball depths	18
Table 1—Height/caliper relationship for type 1 shade trees	4
Table 2—Height, caliper, and branching relationships— type 3 small upright trees	6
Table 3—Branching—type 4 small spreading trees.....	7
Table 4—Root ball sizes for shrub form and multi-stem trees ...	12
Table 5—Caliper/height/root spread relationship— nursery grown bare root trees.....	13
Table 6—Root ball diameters—field grown trees	16
Table 7—Root ball diameters—processed balled trees	19
Table 8—Container class guidelines—shade and flowering trees.....	20
Table 9—Fabric bag sizes-trees	22

Section 2: Deciduous Shrubs

2.1 Specifications—general	23
2.1.1—Required specifications	23
2.1.1.1 Plant size intervals.....	23
2.1.1.2 Definition of “cane”	23
2.1.1.3 Spread and height measurements	23
2.1.2 Optional specifications and quality designations... 24	

2.1.2.1 Minimum number of canes	24
2.1.2.2 Transplanting or root pruning	24
2.1.2.3 Specimen designation	24

2.2 Types of deciduous shrubs

2.2.1 Type 0—Tender shrubs.....	24
2.2.2 Type 1—Small or dwarf.....	25
2.2.3 Type 2—Intermediate	26
2.2.4 Type 3—Large or tall	27

2.3 Bare root specifications

2.3.1 Nursery grown—spread of roots.....	28
2.3.2 Collected—spread of roots	29

2.4 Root ball guidelines

2.4.1 Root ball diameters—field grown deciduous shrubs ...	29
2.4.2 Plant in center of root ball	30
2.4.3 Root ball depths	31
2.4.4 Burlapping	31
2.4.5 Ball supporting devices	31
2.4.6 Field potted plants.....	31
2.4.7 Processed balled plants.....	32
2.4.8 Collected plants	32
2.4.9 Plantation grown plants	32
2.4.10 Use of digging machines	32

2.5 Container grown specifications.....

2.6 In-ground fabric bag-grown.....

SECTION 2 FIGURES AND TABLES

Figure 10—Types of deciduous shrubs.....	27
Figure 11—Typical type 2 intermediate deciduous shrubs ...	28
Figure 12—Center of plant in center of root ball	30
Figure 13—Measurement of field grown deciduous shrubs....	30
Figure 14—Ball depths: field grown deciduous shrubs	31
Table 10—Height or spread relationship to number of canes and spread of roots or root ball diameter— type 0 deciduous shrubs	25
Table 11—Height or spread relationship to number of canes and spread of roots or root ball diameter— type 1 deciduous shrubs	26

Table 12— Height or spread relationship to number of canes and spread of roots or root ball diameter— type 2 deciduous shrubs	26
Table 13—Height or spread relationship to number of canes and spread of roots or root ball diameter — type 3 deciduous shrubs	28
Table 14—Container class guidelines—deciduous shrubs....	33
Table 15—Fabric bag sizes—deciduous shrubs	34

Section 3: Coniferous Evergreens

3.1 Specifications—general	35
3.1.1 Required specifications	35
3.1.1.1 Plant size intervals.....	35
3.1.1.2 Spread and height measurements	35
3.1.2 Shearing designations	36
3.1.3 Determining root ball, container, or fabric bag size ...	37
3.1.4 Optional specifications and quality designations ...	37
3.1.4.1 Height and spread	37
3.1.4.2 Transplanting or root pruning	37
3.1.4.3 Specimen or quality grade designation, collected stock.....	38
3.1.4.4 Minimum or maximum caliper	38
3.1.5 Dwarf conifers	38
3.2 Types of conifers	38
3.2.1 Type 1 creeping or prostrate	38
3.2.2 Type 2 semi-spreading.....	38
3.2.3 Type 3 broad spreading, globe, and compact upright...	39
3.2.4 Type 4 cone type (pyramidal)	40
3.2.5 Type 5 broad upright.....	42
3.2.6 Type 6 columnar type	43
3.3 Root ball guidelines	44
3.3.1 Root ball diameters—field grown coniferous evergreens	44
3.3.1.1 Natural and semi-sheared	47
3.3.1.2 Sheared.....	47
3.3.1.3 Dwarf varieties	47
3.3.2 Trunk in center of ball	47
3.3.3 Ball depths	47

3.3.4 Burlapping	48
3.3.5 Ball supporting devices.....	48
3.3.6 Collected	48
3.3.7 Plantation grown.....	49
3.3.8 Field potted	49
3.3.9 Use of digging machines	49
3.4 Container grown specifications.....	49
3.5 In-ground fabric bag-grown.....	51

SECTION 3 FIGURES AND TABLES

Figure 15—Measurement—types 1 and 2 coniferous evergreens	36
Figure 16—Measurement—type 3 coniferous evergreens....	40
Figure 17—Measurement —type 4 coniferous evergreens...	41
Figure 18—Determining average height —type 4 coniferous evergreens	42
Figure 19—Measurement—type 5 coniferous evergreens....	43
Figure 20—Measurement —type 6 coniferous evergreens...	44
Figure 21—Example: trunk in center of earth ball.....	47
Figure 22—Ball depths—coniferous evergreens	48
Table 16—Type 3 coniferous evergreens.....	40
Table 17—Type 4 coniferous evergreens.....	41
Table 18—Type 5 coniferous evergreens.....	42
Table 19—Type 6 coniferous evergreens.....	43
Table 20—Ball sizes—coniferous evergreens	46
Table 21—Container class guidelines—natural, semi-sheared, or lightly sheared evergreens.....	50
Table 22—Fabric bag sizes—coniferous evergreens.....	52

Section 4: Broadleaf Evergreens

4.1 Specifications—General	53
4.1.1 Required specifications	53
4.1.1.1 Plant size intervals.....	53
4.1.1.2 Spread and height measurements	53
4.1.2 Shearing designations	54
4.1.3 Determining root ball, container, or fabric bag size ...	54
4.1.4 Optional specifications and quality designations ...	55

4.1.4.1 Height and spread	55
4.1.4.2 Transplanting or root pruning	55
4.1.4.3 Specimen or quality grade designation, collected stock	55
4.1.4.4 Minimum or maximum caliper	55
4.1.5 Dwarf broadleaf evergreens	55
4.2 Types of broadleaf evergreens	56
4.2.1 Type 1—Spreading type	56
4.2.2 Type 2—Semi-spreading type	56
4.2.3 Type 3—Broad spreading, globe, or compact upright type	57
4.2.4 Type 4—Broad upright type	58
4.2.5 Type 5—Cone type	59
4.2.6 Type 6—Columnar type	60
4.3 Root ball guidelines	61
4.3.1 Root ball diameters—field grown broadleaf evergreens	61
4.3.1.1 Natural and semi-sheared	63
4.3.1.2 Sheared	63
4.3.1.3 Dwarf varieties	63
4.3.2 Trunk in center of ball	63
4.3.3 Ball depths	63
4.3.4 Burlapping	64
4.3.5 Ball supporting devices	64
4.3.6 Collected	64
4.3.7 Plantation grown	65
4.3.8 Field potted	65
4.3.9 Use of digging machines	65
4.4 Container grown specifications.....	65
4.5 In-ground fabric bag-grown.....	67

SECTION 4 FIGURES AND TABLES

Figure 23—Measurement—type 1 broadleaf evergreens	56
Figure 24— Measurement—type 2 broadleaf evergreens ...	57
Figure 25—Measurement—type 3 broadleaf evergreens	58
Figure 26—Measurement—type 4 broadleaf evergreens	59
Figure 27—Measurement—type 5 broadleaf evergreens	60

Figure 28—Example: trunk in center of earth ball.....	63
Figure 29—Ball depth measurement.....	64
Table 23—Type 3 broadleaf evergreens	57
Table 24—Type 4 and 5 broadleaf evergreens	58
Table 25—Type 6 broadleaf evergreens	60
Table 26—Ball sizes—broadleaf evergreens.....	62
Table 27—Container class guidelines—natural, semi, or lightly sheared	66
Table 28—Fabric bag sizes—types 4 and 5 broadleaf evergreens	67

Section 5: Rose Grades

5.1 General garden rose	68
5.2 Hybrid tea, tea, grandiflora, rugosa hybrids, hybrid perpetuals, moss, and climbing roses.....	68
5.3 Polyantha, shrub, landscape, and low growing floribunda roses.....	69
5.4 Field grown miniatures	70
5.4.1 Large grower	70
5.4.2 Small grower	70
5.4.3 Root system	71
5.5 Tree roses	71
5.5.1 Standard tree rose 36" (91 cm)	71
5.5.2 Patio tree rose 18 inches (50 cm).....	71
5.5.3 Mini-tree rose—(miniature varieties).....	71
5.6 Container grown roses.....	72

SECTION 5 FIGURES AND TABLES

Figure 30—Hybrid tea, tea, grandiflora, etc., roses	69
Figure 31—Climbing roses.....	69
Figure 32—Polyantha roses.....	70
Figure 33—Floribunda roses	70
Figure 34—Tree roses	72

Section 6: Young Plants

6.1 General specifications	73
---	-----------

6.1.1 Cultural history or age specifications	73	7.2.1 Deciduous	79
6.1.1.1 Propagation and cultural history codes	73	7.2.2 General	79
6.1.2 Quality definition	74	7.2.3 Processed balled	80
6.1.3 Unrooted cuttings	74	7.2.4 Fruit seedlings	81
6.1.4 Micropropagated plants (<i>in vitro</i> and <i>ex vitro</i>)	74	7.2.4.1 Caliper measurement	81
6.1.5 Pruning	74	7.2.4.2 Special specification	81
6.2 Method of measurement	74	7.2.4.3 Vegetatively propagated/micropropagated fruit stock	81
6.3 Sizing intervals	75	7.2.4.3.1 Special specification (root system)	81
6.3.1 Slow grower (dwarf and semi-dwarf)	75	7.2.5 Citrus	82
6.3.2 Medium grower	75	7.3 Container grown	82
6.3.3 Fast grower	75	7.4 Size classification of mature trees	82
6.4 Types of plants	75		
6.4.1 Type 1—No stems	75		
6.4.2 Type 2—Single stem	75		
6.4.2.1 Spreading	75		
6.4.2.2 Semi-spreading	76		
6.4.2.3 Globe	76		
6.4.2.4 Medium upright	76		
6.4.2.5 Upright	76		
6.4.3 Type 3—Stoloniferous	76		
6.4.4 Type 4—Rhizomatous, tuberous, or fibrous roots	76		
6.4.5 Type 5—Fans	76		
6.4.6 Type 6—Bulbs, corms	77		
6.4.7 Type 7—Vines	77		
6.4.8 Conifer plantation and reforestation plants	77		
6.5 Unclassified	77		
6.6 Plants sold in containers and plug cells	77		
6.6.1 Plug cell specifications	77		

Section 7: Fruit Tree Grades

7.1 General specifications	78
7.1.1 Quality definition	78
7.1.2 Cultural designations	78
7.1.2.1 Unrooted cuttings	78
7.1.2.2 Micropropagated plants (<i>in vitro</i> and <i>ex vitro</i>)	78
7.2 Method of measurement	79

SECTION 7 TABLES

Table 29—Height/caliper relationship for standard apple, sweet cherry, peach, almond, nectarine, pear, apricot, prune, and plum (one and two years)	79
Table 30—Height/caliper relationship for standard sour-cherry and dwarf peach, pear, nectarine, apricot, prune and plum (on clonal rootstock only)	80
Table 31—Height/caliper relationship for dwarf apple (including clonal rootstock and interstem trees)	80
Table 32—Ball sizes—processed balled fruit trees	81
Table 33—Apple rootstocks/interstems	82
Table 34—Pear rootstocks	83
Table 35—Peach, nectarine, and almond rootstocks	83
Table 36—Plum and apricot rootstocks	84
Table 37—Cherry rootstocks	84

Section 8: Small Fruits

8.1 General specifications	85
8.1.1 Quality definitions	85
8.1.2 Designation	85
8.1.2.1 Unrooted cuttings	85
8.1.2.2 Micropropagated plants (<i>in vitro</i> and <i>ex vitro</i>)	85
8.2 Method of measurement	86
8.2.1 Raspberries	86
8.2.1.1 Sucker and root cutting plants	86

8.2.2 Transplanted raspberries	86
8.2.3 Dewberries, blackberries, boysenberries, youngberries	86
8.2.3.1 Root cuttings	86
8.2.4 Transplanted blackberries	86
8.2.5 Currants	86
8.2.6 Blueberries	87
8.2.7 Gooseberries	87
8.2.8 Grape vines	87
8.2.9 Strawberry plants	87
8.2.10 Asparagus crowns	87
8.3 Container grown	88

SECTION 8 FIGURES

Figure 35—Strawberries—minimum requirements	88
---	----

Section 9: Understock

9.1 General specifications	89
9.1.1 Quality definition	89
9.1.2 Designation	89
9.1.2.1 Unrooted cuttings	90
9.2 Method of measurement	90
9.2.1 Measurement designation	90
9.3 Types of plants	90
9.3.1 Fruit and nut seedlings—seed-propagated stock ...	90
9.3.1.1 Seedlings with limbs	90
9.3.1.2 Root descriptions	90
9.3.2 Vegetatively propagated plants	91
9.3.2.1 From layering	91
9.3.2.2 Hardwood cuttings	91
9.3.2.3 Softwood cuttings	91
9.3.2.4 Micropropagated plants (<i>in vitro</i> and <i>ex vitro</i>) ...	91
9.3.3 Unclassified	91
9.4 Evergreen lining out stock— recommendations	91
9.5 Shade and flowering tree seedlings	92
9.6 Container grown	92

Section 10: Seedling Trees and Shrubs

10.1 General specifications	93
10.1.1 Quality definition	93
10.1.2 Designation	93
10.2 Method of measurement	94
10.2.1 Deciduous or hardwood	94
10.2.2 Coniferous evergreens	95
10.3 Container grown	95

SECTION 10 TABLES

Table 38—Minimum heights and root lengths for seedling calipers	94
Table 39—Minimum calipers for seedling heights and root lengths	94
Table 40—Coniferous evergreen seedlings	95

Section 11: Bulbs, Corms, and Tubers

11.1 General	96
11.2 Amaryllis	96
11.3 Anemones	96
11.4 Begonias (tuberous)	97
11.5 Caladiums	97
11.6 Callas	97
11.7 Cannas	97
11.8 Crocosmia	97
11.9 Crocus	98
11.10 Dahlias	98
11.11 Freesias	98
11.12 Gladiolus	98
11.13 Gloxinia (tuberous)	99
11.14 Hyacinths	99
11.15 Iris—dutch iris	99
11.16 Liatris	100
11.17 Lilies	100
11.18 Muscari (grape hyacinths)	100
11.19 Narcissus and daffodils	100
11.19.1 Double nose	100

11.19.2 Round.....	101
11.20 Narcissus—paper white	102
11.21 Ranunculus	102
11.22 Tulips	102
11.23 Tuberoses.....	102

Section 12: Herbaceous Perennials, Ornamental Grasses, Groundcovers, and Vines

12.1 General specifications	103
12.1.1 Types (form in which marketed):.....	103
12.1.2 Propagation methods.....	103
12.1.3 Container grown plants	104
12.2 Herbaceous perennials sold by eye divisions, fans, or rhizomes.....	104
12.2.1 Astilbe	104
12.2.2 Dicentra—bleeding Heart	104
12.2.3 Hemerocallis—Daylily	104
12.2.4 Hosta ssp.—Funkia.....	105

12.2.5 Iris	105
12.2.6 Paeonia—Peony	105
12.2.7 Papaver orientale—Oriental Poppy	106
12.3 Other herbaceous perennials.....	106
12.4 Ornamental grasses	107
12.5 Groundcovers.....	107
12.6 Vines	107

SECTION 12 FIGURES

Figure 36—Examples of typical grades for Hemerocallis...	105
Figure 37—Examples of typical sizes for Paeonia	106

Section 13: Christmas Tree Standards...108

Appendix A: Glossary	109
Appendix B: Metric equivalents	112
Appendix C: Letter of Recommendation	113

FOREWORD

One of the early activities of the American Nursery & Landscape Association, formerly the American Association of Nurserymen, was the development of a standardized system of sizing and describing plants to facilitate the trade in nursery stock. Since 1921, the Association has maintained an active committee on standards. Its first edition of "Horticultural Standards" was published in 1923. From time to time, these standards were revised and expanded to meet the needs of the industry.

After World War II the Association elected to make the standards a national standard by adhering to the procedures of the American Standards Association. The first edition published under the procedures of the American Standards Association (forerunner of the current American National Standards Institute, or "ANSI") was published on June 22, 1949.

The revisions included in the 2004 edition were developed by the Association's Horticultural Standards Committee from January, 1997, through May, 2003. The proposed revisions were then submitted to interested national and regional societies, associations, companies, individuals, and government agencies for their review and endorsement.

Nomenclature

The following manuals are suggested for general nomenclature use:

List of Names of Woody Plants; List of Names of Perennials. Research Station for Nursery Stock, P.O. Box 118, NL-2770 AC BOSKOOP, The Netherlands. 5th Revised Ed., 1995.

Datascape Guide to Commercial Nomenclature, American Nurserymen Publishing Co., Chicago, IL, 1996.

An Annotated Checklist of Woody Ornamental Plants of California, Oregon and Washington, Division of Agricultural Sciences, University of California, February, 1979.

Hillier's Manual of Trees and Shrubs, 6th Edition, 1993.

Manual of Cultivated Conifers, Den Ouden & Boon, 3rd Edition, 1982.

The following botanical manuals are suggested for nomenclature as well as descriptive and technical data:

Trees and Shrubs Hardy in the British Isles, Beam (four volumes).

Hortus Third, Liberty Hyde Bailey Hortorium, 1976.

Dictionary of Gardening, Royal Horticulture Society (five volumes).

A Technical Glossary of Horticultural and Landscape Terminology, Horticultural Research Institute, 1971.

CONTAINER SIZE SPECIFICATIONS

All container-grown nursery stock specifications based on the *American Standard for Nursery Stock* (the “Standard”) must include both plant size and container class.

If only container class is stated, the specification is incomplete, and the Standard does not provide a corresponding minimum plant size (but see exception in Section 12 for certain perennials). Tables throughout the Standard provide guidelines to determine the appropriate container class for the specified plant size (See Tables 8, 14, 21, and 27).

Specifications: Properly written specifications in catalogues or contract documents that are intended to be in accordance with the Standard must refer to a container class in accordance with the Container Class Table shown below, using the “#” symbol. Containers marketed and sold that indicate a “trade” or “#” designation must have volumes within the ranges shown in order to comply with the Standard. However, parties to a transaction may agree that nursery stock will be in an “unclassified” container, which is a container with a volume not included within the recommended container class volume ranges.

Relation of Container Classes with Imperial Volumes: Each container class includes a range of acceptable container volumes, and is not limited to a single container volume (e.g., a certain number of “gallons”). The volume ranges for container classes #1 through #100 include the volume of a container that, if such a container were manufactured, would hold the equivalent number of gallons as the container class number. Standard users should refer to container manufacturers’ volume specifications for compliance with the Standard. ***Nursery stock specifications that reference only an imperial volume measurement, such as “quarts” or “gallons,” are not in accordance with the Standard.***

Small Plant Containers (“SP” designation): Generally, containers commonly referenced in the industry as ‘4-inch’ or ‘quart’ containers are #SP4 containers (1 qt. = 57.75 cubic inches). If growers, buyers or specifiers include dimension measurements or imperial volume references, they are encouraged to also specify ‘round’ or ‘square,’ and to reference the appropriate container classification in the Container Class Table in order to assure adequate soil volume in the container. ***Dimension measurements for square containers shall be taken along one side and not diagonally.***

Retail Consumer Transactions: The Standard is only applicable to nursery stock transactions within the trade, and does not apply to retail consumer transactions. The Standard does not recognize or sanction the practice of using only an imperial volume or dimension measurement of a certain container to purport to indicate the size of a plant in retail consumer transactions.

Wooden Box Size Equivalents: For purposes of the Container Class Table, wooden box size “equivalent” indicates that a wooden box size may be specified in lieu of the indicated equivalent container class, and nursery stock in an equivalent wooden box size shall be accepted in the trade as in conformance with a specification for container-grown nursery stock in the equivalent container class indicated, and vice-versa. Wooden boxes are not required to have volumes that are “equal to” or within the volume range of the indicated equivalent container class, or vice-versa.

CONTAINER CLASS TABLE

CONTAINER CLASS	CONTAINER VOLUME		WOODEN BOX SIZE EQUIVALENT
	Cubic inches min - max	Cubic centimeters min - max	
#SP1	6.5 - 8.0	106 - 131	
#SP2	13.0 - 15.0	213 - 246	
#SP3	20.0 - 30.0	328 - 492	
#SP4	51 - 63	836 - 1033	
#SP5	93 - 136	1524 - 2229	
#1	152 - 251	2492 - 4115	
#2	320 - 474	5246 - 7770	
#3	628 - 742	10285 - 12164	
#5	785 - 1242	12860 - 20360	
#7	1337 - 1790	21913 - 29343	
#10	2080 - 2646	34090 - 43376	
#15	2768 - 3696	45376 - 60589	
#20	4520 - 5152	74096 - 84457	20-inch box
#25	5775 - 6861	94669 - 112472	24-inch box
#45	9356 - 11,434	153317 - 187377	36-inch box
#65	13514 - 16517	221456 - 246051	42-inch box
#95/100	20790 - 25410	340686 - 416394	48-inch box

IN-GROUND FABRIC BAG SPECIFICATIONS

Recommended minimum fabric bag diameters, depths and cubic volumes are as follows:

Fabric bag diameter	Fabric bag depth	Fabric bag volume
10 inches	11 inches	864 cubic inches
12 inches	11 inches	1244 cubic inches
14 inches	13 inches	2001 cubic inches
16 inches	13 inches	2614 cubic inches
18 inches	15 inches	3817 cubic inches
20 inches	15 inches	4712 cubic inches
22 inches	17 inches	6462 cubic inches
24 inches	17 inches	7691 cubic inches

HOW TO USE THIS PUBLICATION

A. General Information.

The purpose of the American Standard for Nursery Stock is to provide buyers and sellers of nursery stock with a common terminology in order to facilitate transactions involving nursery stock. For instance, the standards establish common techniques for (a) measuring plants, (b) specifying and stating the size of plants, (c) determining the proper relationship between height and caliper, or height and width, and (d) determining whether a root ball or container is large enough for a particular size plant. In other words, this book is a communication tool, and does not provide buyers with any assurance of the health or quality of the nursery stock being specified or sold.

In order to locate the specifications for a particular plant, you should know (a) what type of plant it is, such as whether it is a shade or flowering tree, a coniferous or broadleaf evergreen, a young plant (seedlings, ground covers, or lining out stock), a perennial or bulb, etc., (b) the growth habit of the particular species, (e.g., upright, conical, spreading, multi-stemmed, etc.), and (c) the method of production of the plant and the manner in which the plant will be sold (e.g., balled and burlapped, bare root, containerized, etc.).

B. Organization and Procedure

1. Locate the plant group to which the plant belongs. There are thirteen plant groups: Shade and Flowering Trees, Deciduous Shrubs, Coniferous Evergreens, Broadleaf Evergreens, Roses, Young Plants, Fruit Trees, Small Fruits, Understock, Seedlings, Bulbs, Corms, and Tubers, Perennials, and Christmas Trees.
2. Locate the section within that plant group which most likely contains the type of information you want to find. The first portion of each plant group section contains general information on how the plants in that group are measured, the conventions regarding how measurements are to be stated, and how different types of plants within the plant group are divided. Each plant group is further divided depending on the most important considerations for plants in that group. The sections for trees and shrubs, for instance, are divided based on growth habit and methods of production and sale. Other sections are divided based on propagation methods, specific plant families within the plant group, or other factors.

Examples of plant types within certain plant groups are only to clarify the factors used to determine plant types within each section. Only a few examples are listed, and are not complete lists of all genera within each plant type. Users must have horticultural knowledge or access to horticultural resources to determine the plant type of an unlisted species.

3. If you are unable to locate the information under the first plant group selected, you should go back to the Table of Contents and determine whether there may be another plant group to which the plant belongs.
4. The Appendix provides both a glossary of terms used in the Standard as well as a metric conversion table

THE ANLA HORTICULTURAL STANDARDS COMMITTEE

The ANLA Horticultural Standards Committee oversees the administration of the revisions to the *American Standard for Nursery Stock* (ANSI Z60.1). The following individuals served on the committee for various periods of time between 1997 and 2004:

Alan M. Jones, Manor View Farm Inc.
Bert T. Swanson, Swanson's Nursery Consulting Inc
Barry Hargrove, Southern Hills Country Club
Bradley F. Brown, Glacier Nursery Inc
Charles H. Huecker, Weeks Wholesale Rose Grower Inc
Dave Fujino, Hines Horticulture Inc
David Byers, Byers Wholesale Nursery Inc
David M. Taylor, Concord Nurseries Inc
E.B. Gee, III, Heartland Nursery Company
Earl F. Ervey, Blue Sterling Nursery
Edward F. Gilman, University of Florida
Frank E. Janosz, English Gardens Nursery
Frank Hopkins, Horticultural Materials/Systems Inc
Gary W. Watson, The Morton Arboretum
Hugh K. Steavenson, Forrest Keeling Nursery
J. Frank Schmidt, III, J Frank Schmidt & Son Co
Janet Rademacher, Monrovia Growers Inc
Joanne C. Kostecky, Joanne Kostecky GARDEN DESIGN Inc
Joe Burks, Certified Roses Inc
Joseph F. Jamison, Jr, Brandywine Nurseries Inc
Larry Burks, Certified Roses Inc
Leon Taylor, Greenleaf Nursery Co
Loren Blum, English Gardens Nursery
Louis Hillenmeyer, III, Louis' Flower Power Shops
M.E. Gardner, Stribling's Nurseries Inc
Mark Buchholz, Monrovia Growers Inc
Mark Dehmlow, Swede Valley Inc
Martha Simon Pindale, Bluemount Nurseries Inc
Paul Pagliarini, Central Nurseries Inc
R. Wayne Mezitt, Weston Nurseries Inc
Richard B. Campbell, Campbell's Nursery & Garden Center
Richard Bocci, Carlton Plants
Richard J. Henkel, Princeton Horticultural Services
Robert Terry, Fisher Farms LLC
Roger F. Fick, Wilson Nurseries Inc
Ronald R. Amos, Evergreen Nursery Co Inc
Ronnie Swaim, Gilmore Plant & Bulb Co Inc
Steve Batka, Zelenka Nursery LLC
Thomas Pinney, Jr., Evergreen Nursery Co Inc
Timothy Bailey, Bailey Nurseries Inc
Todd Erickson, Meadow Lake Nursery Co
Tom Vanicek, Grow Northeast
William S. Stensson, Sheridan Nurseries Limited
ANLA Staff Administrator, Warren A. Quinn

Canvass List

Consensus for this standard was achieved by use of the Canvass Method.

The following organizations participated in the revisions of this standard prior to submittal to ANSI. Inclusion of this list does not necessarily imply that the organization concurred with the submittal of the proposed standard to ANSI.

American Forests Historic Trees
Associated Landscape Contractors of America
Association of Professional Landscape Designers
Champ Tree Project
City of Frederick, Dept. of Public Works
Clark Nexsen
Colorado Dept. of Agriculture
Connecticut Dept. of Transportation
Dewberry & Davis, LLC
Fairplains Nursery
Home Nursery Inc
International Society of Arboriculture
Jackson & Perkins Wholesale
Kurt Bluemel Inc
Law's Nursery Inc
Lawyer Nursery Inc
National Garden Center Organization
National Landscape Association
North Carolina Department of Transportation
Nursery Supplies Inc
Oakland County MI Dept. of Facilities Management - Grounds Unit
Scarff's Nursery Inc
US National Arboretum
Valley Crest Tree Company
Westenberger Tree Service Inc
Wholesale Nursery Growers of America
Zelenka Nursery Inc

Section 1: Shade and Flowering Trees

This section applies to plants generally sold to the retail and landscape trade. For lining out stock, including whips, see Section 6.

1.1 Specifications – general

1.1.1 Required specifications

For **bare root** (Section 1.5) and **field grown** stock (Section 1.6), specifications shall include plant size, by height or caliper, as appropriate to the plant type.

For **container** grown stock (Section 1.7) and **box-grown** stock (Section 1.8), specifications shall include plant size, by height or caliper, as appropriate to the plant type, and container class or box size.

For **fabric bag** grown stock (Section 1.9), specifications shall include plant size by caliper and minimum fabric bag size.

Unless otherwise specified, all shade and flowering trees should be single-trunk.

Shrub form, clump form, or multi-stem trees, specimen trees, or trees for particular uses (e.g., street trees) require additional specifications as set forth in the appropriate sections, below.

1.1.1.1 Plant size intervals

General practice is for a **plant size designation** to express only the minimum for the desired size interval. That size will be the minimum size allowable for that size interval and shall include plants from that size up to but not including the next larger size interval. Acceptable size intervals for each plant type are shown in the appropriate plant type sections, below (see Section 1.2). For instance, a specification for a “2.5 in. cal.” Type 1 shade tree references the “2.5 to 3 inch” caliper size interval, while a specification for a “5 ft.” Type 4 spreading tree references the “5-6 ft.” height size interval.

1.1.1.2 Methods of caliper and height measurement

Height measurement shall be taken from ground level for field grown stock and from the soil line for container grown stock, which should be at or near the top of the root flare.

Caliper measurement of the trunk shall be taken six inches above the ground up to and including four-inch caliper size. If the caliper at six inches above the ground exceeds four inches, the caliper should be measured at 12 inches above the ground.

Seldom are tree trunks perfectly round. The most accurate measurement will result from the use of a diameter tape. Caliper measurements taken with manual or electronic “slot” or “pincer” type caliper tools should be the average of the smallest and largest measurements.

For Type 1 and Type 2 **field-grown** shade trees, measurement indicates caliper in inches, and caliper shall take precedence over height if a height measurement is also provided.

For Type 1 and Type 2 **bare root** and **container-grown** shade trees, measurement designates height through 7-8' size interval, then caliper in inches thereafter. Both height and caliper measurement may be provided for all sizes.

For Type 3 and Type 4 **field grown**, **bare root**, and **container grown** small and flowering trees, measurement indicates height in feet through 5-6' size interval, then caliper in inches thereafter. Both height and caliper measurement may be provided for all sizes.

For all trees grown in in-ground **fabric bags**, measurement indicates caliper in inches.

1.1.2 Optional specifications and quality designations

Nursery stock shipped in accordance with the required specifications shall be deemed to be acceptable within the terms of this section if it is typical in size and habit for the species in the region of the country in which it is grown unless specifications include additional details. Specifiers and buyers are encouraged to provide additional appropriately detailed descriptive language to the extent that required specifications set forth in Section 1.1.1 do not provide sufficient detail for a particular transaction.

1.1.2.1 Height and caliper

If only height or caliper shall be specified, both height and caliper may be specified.

1.1.2.2 Transplanting requirements

In certain landscapes, such as street tree or container plantings with limited soil availability, or when the buyer desires a particularly well-formed root mass, specifications should include the minimum number of times that nursery stock shall have been transplanted (e.g., "trans. 3x") or root pruned. In such cases, nursery stock may be shipped with a root ball smaller than that shown in Table 6, and the smaller root ball should be specified. Root ball sizes in Table 6 are based on trees that have not been transplanted after they have been lined out in the field, which is the typical and accepted practice in the industry.

1.1.2.3 Specimen or quality grade designation

When "specimen" or "quality grade" trees are called for in landscape specifications, the desired characteristics shall be stated. Specifications should include deviations from standard minimums for caliper, height, root ball diameter, container or box size, etc., as well as other factors such as symmetry, crown width, fullness of branching, single or single dominant leader, age, specialized pruning techniques, or uniqueness of the plant. The determination of compliance with the term "specimen" shall be determined with reference to the descriptive characteristics provided in the specifier's or buyer's specifications.

1.1.2.4 Height of branching – street trees

Bid specifications for trees for street plantings shall specify the height to which the tree should be free of branching. The height of branching specification shall bear a relationship to the size and kind of tree, so that the crown of the tree is in good balance with the trunk.

Examples:

Acer platanoides, 2 in. cal., 12 to 14 ft., trunk free of branches 6 to 7 ft.

Quercus rubra 3½ in. cal., 14 to 16 ft., trunk free of branches 7 to 9 ft.

Trees with ascending branches (Examples - *Ulmus americana* and *Zelkova serrata*) may be branched 1 foot or more below the standard height and still provide proper clearance, which is the purpose of this specification.

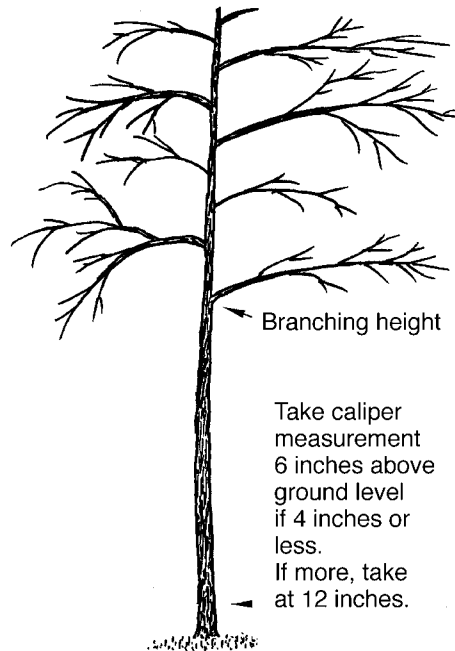

FIGURE 1 – Caliper and branching height

1.1.2.5 Trees for other uses

Where a certain form of growth is desired which is not in accordance with a natural growth habit, this form should be so specified.

Examples:

Cut back or sheared - trees that have been pruned back so as to multiply the branching structure and to develop a more formal effect.

Topiary – sheared or trimmed closely in a formal geometric pattern.

Espaliered – trained on a structure of a specified shape and style.

Street tree – trunk clear of branches up to a certain height on the trunk. See Section 1.1.2.4

1.2 Types of trees

1.2.1 Type 1 shade trees

Definition: The height relationship to caliper, for most standard shade trees, is shown in Table 1, below.

It is recognized that climatic conditions in different sections of the country produce trees of different caliper-height proportions. Trees from one region of the country may have less caliper in proportion to height while trees from another region may have greater caliper in proportion to height than shown in the following table. The table below shows the average height range and the typical maximum heights.

Table 1 - Height/caliper relationship for Type 1 shade trees

Caliper	Average height range	Typical maximum height
½ in.	4 to 5 ft.	6 ft.
5/8 in.	5 to 6 ft.	8 ft.
¾ in.	6 to 8 ft.	10 ft.
1 in.	8 to 10 ft.	11 ft.
1 ¼ in.	8 to 10 ft.	12 ft.
1 ½ in.	10 to 12 ft.	14 ft.
1 ¾ in.	10 to 12 ft.	14 ft.
2 in.	12 to 14 ft.	16 ft.
2 ½ in.	12 to 14 ft.	16 ft.
3 in.	14 to 16 ft.	18 ft.
3 ½ in.	14 to 16 ft.	18 ft.
4 in.	16 to 18 ft.	22 ft.
4 ½ in.	16 to 18 ft.	22 ft.
5 in.	18 ft. and up	26 ft.

Examples: *Acacia stenophylla*, *Acer rubrum*, *A. saccharinum*, *Betula nigra*, *Bucida bucerus*, *Cinnamomum camphora*, *Eucalyptus microtheca*, *Fraxinus pennsylvanica*, *Ginkgo*, *Gleditsia triacanthos*, *Liriodendron tulipifera*, *Platanus occidentalis*, *Populus fremontii*, *Quercus macrocarpa*, *Q. palustris*, *Q. phellos*, *Q. virginiana*, *Salix*, *Swietenia mahogany*, *Tilia americana*, *Zelkova serrata*

Measurement:

Caliper measurements shall be 1/8-inch intervals from 1/2" through 3/4", 1/4-inch intervals through 1 3/4-2", then 1/2-inch intervals through 5 1/2-6", then one-inch intervals through 9-10", then two-inch intervals from 10-12" and up. Decimal equivalents to fractions may be used.

For bare root and container-grown stock only, through 7-8' size designation, height measurements shall be in one-foot increments. Thereafter, measurement indicates caliper.

1.2.2 Type 2 shade trees

Definition: Trees of slower growth than Type 1 that will not usually attain the height measurement in relation to caliper as in Type 1. The height, however, should not be less than two-thirds the height relationship given for Type 1 (See Table 1).

Examples: *Aesculus pavia*, *Brachychiton acerifolius*, *Celtis reticulata*, *Cladrastis lutea* (*kentukea*), *Cocculus laurifolius*, *Conocarpus erectus* var. *sericeus*, *Fagus sylvatica*, *Koelreuteria paniculata*, *Liquidambar styraciflua*, *Magnolia grandiflora*, *Nyssa sylvatica*, *Quercus alba*, *Q. fusiformis*, *Sorbus aucuparia*, *Syringa reticulata*, *Tabebuia cariaba*, *Tilia cordata*, *T. euchlora*

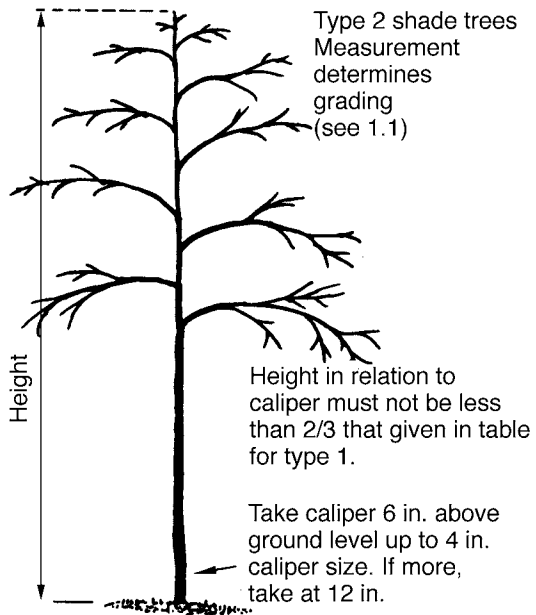

FIGURE 2-Measurement-Type 2 shade trees

Measurement:

Caliper measurements shall be 1/4-inch intervals through 1 3/4-2", then 1/2-inch intervals through 5 1/2-6", then one-inch intervals through 9-10", then two-inch intervals from 10-12" and up. Decimal equivalents to fractions may be used.

For bare root and container-grown stock only, through 7-8' size designation, height measurements shall be in one-foot increments. Thereafter, measurement indicates caliper.

1.2.3 Type 3 small upright trees

Definition: This is a broad group including small, upright trees which may be grown as single-trunk plants, as multi-trunk clumps, or as shrubs.

A height relative to caliper may be specified but shall not be considered in determining minimum diameter ball sizes.

For single-trunk plants, the minimum relationship for height, caliper, and branching will usually be as shown in Table 2, below.

Table 2 – Height, caliper, and branching relationships – Type 3 Small Upright Trees

Height	Caliper	Branching
2 ft.	5/16 in.	Three or more
3 ft.	7/16 in.	Four or more
4 ft.	9/16 in.	Five or more
5 ft.	11/16 in.	Six or more
	¾ in.	Seven or more

Examples: *Acer campestre*, *A. circinatum*, *Cercis*, *Chionanthus virginicus*, *Crataegus*, *Halesia*, *Malus* ‘Adirondack,’ *M.* ‘Sentinel,’ *Osmanthus fragrans*, *Photinia x fraseri*, *Podocarpus macrophyllus*, *Prunus cerasifera* ‘Thundercloud,’ *P. serrulata*, *P. subhirtella*, *Pyrus calleryana* ‘Whitehouse,’ ‘Capitol,’ *Styrax*

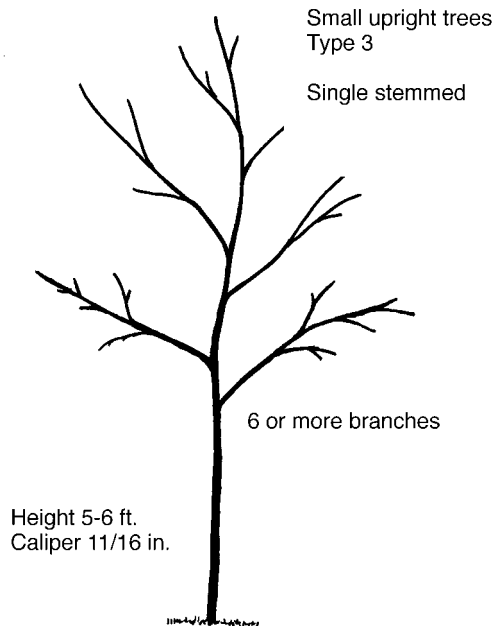

FIGURE 3-Type 3 small upright trees

Measurement:

Height measurement shall be in one-foot intervals. Height shall be the governing measurement through 5-6' interval. Thereafter, caliper takes precedence.

Caliper measurements shall be ¼-inch intervals through 1¾-2", then ½-inch intervals through 5½-6", then one-inch intervals through 9-10", then two-inch intervals from 10-12" and up. Decimal equivalents to fractions may be used.

1.2.4 Type 4 small spreading trees

Definition: This is a broad group including small, spreading trees of dwarf growth habit and certain large shrubs grown in tree or multi-stem form.

A height relative to caliper may be specified but shall not be considered in determining minimum diameter ball sizes.

For single-trunk plants, the minimum branching will usually be as shown in Table 3, below.

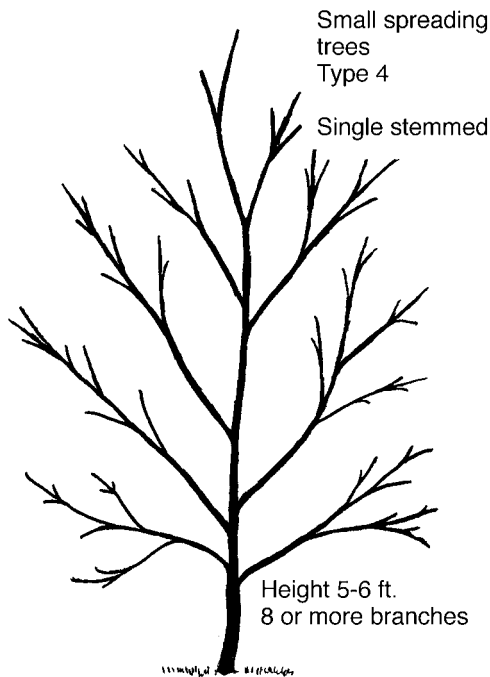

FIGURE 4-Type 4 small spreading trees

Table 3 – Branching – Type 4 – small spreading trees

Height (ft.) or Caliper (in.)	Minimum Branching
2 ft.	Four or more
3 ft.	Five or more
4 ft.	Seven or more
5 ft.	Eight or more
¾ in.	Eight or more

Examples: *Acacia farnesiana*, *Acer palmatum*, *A. griseum*, *Calliandra haematocephala*, *Callistemon viminalis*, *Citris reticulata*, *Conocarpus erectus*, *Cornus florida*, *Laburnum x watereri*, *Lagerstroemia indica*, *Ligustrum japonicum* (tree forms), *L. lucidum*, *Loropetalum chinensis*, *Magnolia x soulangiana*, *M. stellata*, *Malus sargentii*, *Olea europae*, *Viburnum prunifolium*, *Vitex agnuscastus*

Measurement:

Height measurement shall be in one-foot intervals. Height shall be the governing measurement through 5-6' interval. Thereafter, caliper takes precedence, except for shrub-form multi-stem trees (see section 1.3).

Caliper measurements shall be ¼-inch intervals through 1¾-2", then ½-inch intervals through 5½-6", then one-inch intervals through 9-10", then two-inch intervals from 10-12" and up. Decimal equivalents to fractions may be used.

1.3 Shrub form, clump form, or multi-stem trees

Shrub form, clump form, or multi-stem trees occur naturally in many genera or may be manipulated in the nursery. *Larger plants described in this section as "multi-stem" trees may alternatively be specified as "multi-trunk" trees.*

"Suckers" from trunks or from the roots that have branching or form that are not typical for the species or cultivar shall not be treated as "stems" or "trunks."

All specifications shall include whether the form desired is shrub form, clump form, or multi-stem.

Specifications for **shrub form** trees shall include height.

Specifications for **clump form** trees shall include minimum number of stems or trunks, height or caliper, as appropriate to the type, and the method used to determine the caliper measurement if caliper is required.

Specifications for **multi-stem** trees shall include height.

1.3.1 Shrub form trees

1.3.1.1 Definition

This form is determined by the manner in which the plant is maintained, in that generally all persistent, thriving stems arising from the root crown or at a point just above the root crown are retained, and foliage is allowed to remain intact on branches close to the ground. Additional stems may grow from the root crown or at a point just above the root crown and be allowed to grow to maturity throughout the life of the plant, and older stems may be pruned to the ground. Also, species in this group generally do not exceed 15 feet in height at maturity, are generally Type 3 or Type 4 trees, and may naturally produce multiple stems without manipulation in the nursery.

1.3.1.2 Specification

Specifications shall include plant size (height) and shall indicate “shrub form.” See Section 1.1 for additional required specifications. Optional specifications may be included in order to further describe the plant (See Section 1.1.2).

1.3.1.3 Measurement

Measurement shall indicate height, in accordance with Section 1.1.1.2, using the following intervals: one-foot intervals up to 7-8’ height, then two-foot intervals thereafter. Each interval includes plants from the minimum plant size up to but not including the next larger size interval.

Examples:

Narrow or upright habit: *Amelanchier*, *Cornus kousa*, *Crataegus phaenopyrum*, *Lagerstroemia indica*, *L. ‘Apalachee,’* *L. ‘Victor,’* *Syringa vulgaris*, *Viburnum lentago*

Broad or spreading habit: *Acacia minuta*, *Aesculus parviflora*, *Betula nigra ‘Fox Valley,’* *Cornus mas*, *Corylus americana*, *Cotoneaster multiflorus*, *Crataegus crus-galli* var. *inermis*, *Hamamelis vernalis*, *Magnolia ‘Betty,’* *M. stellata*, *Prunus cistena*, *Viburnum lantana*, *V. odoratissimum*, *V. rhytidophyllum*

1.3.2 Clump form and multi-stem trees

1.3.2.1 Definitions

This form is determined by the manner in which the plant is maintained, in that only a certain number of stems or trunks are retained when the plant is young and thereafter maintained as the plant matures, and foliage is generally removed from the lower portion of the plant. It is recognized that, in certain regions of the country, some species are generally sold in the trade as tree forms rather than shrub forms even though they are allowed to retain most of the lower branches and foliage, but only a limited number of main stems or trunks are retained as the tree matures. These are generally Type 1 or Type 2 shade trees.

Clump – Where three or more young trees have been planted in a group and have grown together as a single tree having three or more main stems or trunks. Multiple tree groupings shall have a unified, well-established root system in order to allow harvest, shipment, and planting as a single root ball.

Multi-stem – Where three or more main stems arise from the ground from a single root crown or at a point just above the root crown.

Examples (clump form or multi-stem): *Acer tartaricum* var. *ginnala*, *Alnus glutinosa*, *Amelanchier laevis*, *Betula nigra*, *Carpinus caroliniana*, *Cercidium*, *Cercis Canadensis*, *Cornus alternifolia*, *C. florida*, *Corylus avellana*, *Crataegus punctata*, *Fraxinus pennsylvanica*, *Gleditsia triacanthos* var. *inermis*, *Hamamelis virginiana*, *Lagerstroemia*, *Magnolia x soulangiana*, *M. virginiana*, *Malus floribunda*, *Prosopis*, *Prunus padus*, *Syringa reticulata*, *Tilia cordata*, *T. euchlora*, *Viburnum plicatum*, *V. prunifolium*

Designation as “single trunk, low branching” – Where multiple stems or major branches originate from a single main stem at a point no higher than six inches from the ground. These types are created with specialized techniques rather than as natural to the species (e.g., grafted fruit trees, special forms of *Malus*). This type shall be so specified. If the lowest branches are more than six inches from the ground, specify under Section 1.2 and include “low-branched” specification.

1.3.2.2 Specification

1.3.2.2.1 Clump form trees

Specifications for clump form trees shall include plant size (height or caliper as appropriate - see paragraph below), minimum number of stems or trunks, and method of caliper measurement if a caliper specification is included. A two-stem clump shall be so specified.

Plant size for Types 1 and 2 clump form trees may be specified by height or caliper up to 7-8' height, and then should be specified by caliper thereafter. Types 3 and 4 clump form trees should be specified by height through 5-6', then by caliper thereafter. Specifications for all clump form trees may include both caliper and height measurements.

1.3.2.2.2 Multi-stem trees

Specifications for multi-stem trees should be specified by height. Optional specifications may include the minimum number of stems and caliper measurements. A two-stemmed plant shall be so specified.

1.3.2.3 Caliper measurements – clump form and multi-stem trees

If a caliper measurement is included in the specification, the specification shall also include the method used to determine the caliper measurement, shown below.

In the event that a single caliper measurement is specified without explanation as to the method of measurement used to determine the caliper measurement, the caliper shall be interpreted to be equal to one-half of the total calipers of up to the three largest trunks (Method C, below).

Several methods are used in the trade:

- A. The number of required trunks and the minimum caliper of each trunk.
- B. The number of required trunks and the caliper of only the largest trunk, with all other required trunks within a certain caliper range of the largest trunk (e.g., by percent or within two smaller caliper sizes). This is the Canadian method.
- C. The number of required trunks, caliper specified is one-half (1/2) of the caliper of up to the three largest required trunks.
- D. The number of required trunks, caliper specified is the average of all required trunks.

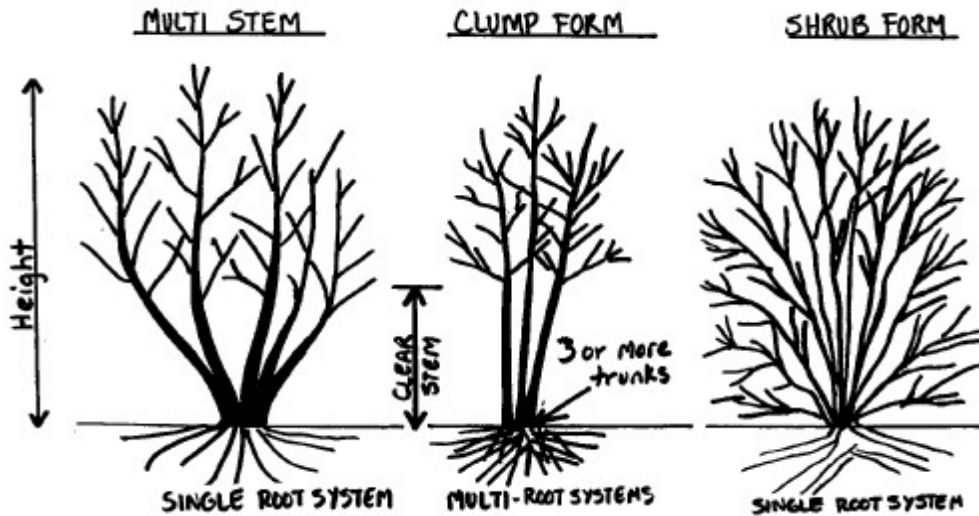

FIGURE 5 – Multi-stem, clump form, and shrub form trees

1.3.2.4 Root ball sizes – shrub form, clump form and multi-stem trees

In all cases, root ball diameters for shrub form, clump form, or multi-stem trees shall satisfy the general requirement stated in Section 1.6.1, below, and root ball depths shall be determined in accordance with Section 1.6.1.1, below.

1.3.2.4.1 Root ball diameters – shrub form trees

Minimum root ball diameters for shrub form trees shall be determined by height, in accordance with Table 4, below.

1.3.2.4.2 Root ball diameters – clump form trees

Minimum root ball diameters for clump form trees shall be determined with reference to Table 6 – Ball Sizes, Nursery Grown Trees, using the caliper equal to *one-half (1/2) of the total caliper of up to the three largest required trunks*, regardless of the method of caliper measurement used in the specification, and even if height only is specified (e.g., for Type 1 or 2 Shade Tree).

For clump form trees with more than 12 inches between the center points of any two trunks, one-half of that distance should be added to the root ball diameter shown in Table 6 to assure that a sufficient amount of roots around the perimeter of the ball are retained during harvest. For instance, if two trunks are 14 inches from center to center, seven inches should be added to the root ball size indicated in Table 6.

A caliper measurement resulting from the application of the formula which falls between a caliper measurement in Table 6 should use the next larger caliper shown in Table 6 (e.g., 3¾-inch caliper, round up to 4-inch caliper, requiring a minimum 42-inch root ball).

1.3.2.4.2 Root ball diameters - multi-stem trees

Minimum root ball diameters for multi-stem trees shall be determined by height, in accordance with Table 4, even if caliper measurements are included in specifications.

Table 4 – Root ball sizes for shrub form and multi-stem trees

	Narrow or Upright Habit Width no more than ½ height at maturity	Broad or Spreading Habit Width at least ½ height at maturity
Average Height	Minimum Diameter Ball	Minimum Diameter Ball
4 ft.	14 in.	24 in.
5 ft.	18 in.	28 in.
6 ft.	22 in.	32 in.
7 ft.	26 in.	36 in.
8 ft.	28 in.	40 in.
10 ft.	32 in.	44 in.
12 ft.	38 in.	52 in.
14 ft.	44 in.	60 in.
16 ft.	50 in.	66 in.
18 ft.	60 in.	74 in.
20 ft.	70 in.	80 in.

1.4 Palms

In size grading palm trees, height shall take precedence. Either of two heights may be specified: overall height or trunk height.

Overall height is the perpendicular height from the ground, which should be at or near the top of the root zone, to the top of the arc made by the uppermost arching frond with the tree standing in natural position.

Trunk height is measured from the ground line, which should be at or near the top of the root zone, to the base of the heart leaf.

In cases where the root ball or box (container) size is not specified, the minimum root ball size or box size recommended in this section shall be deemed acceptable (see Table 6 or Table 7).

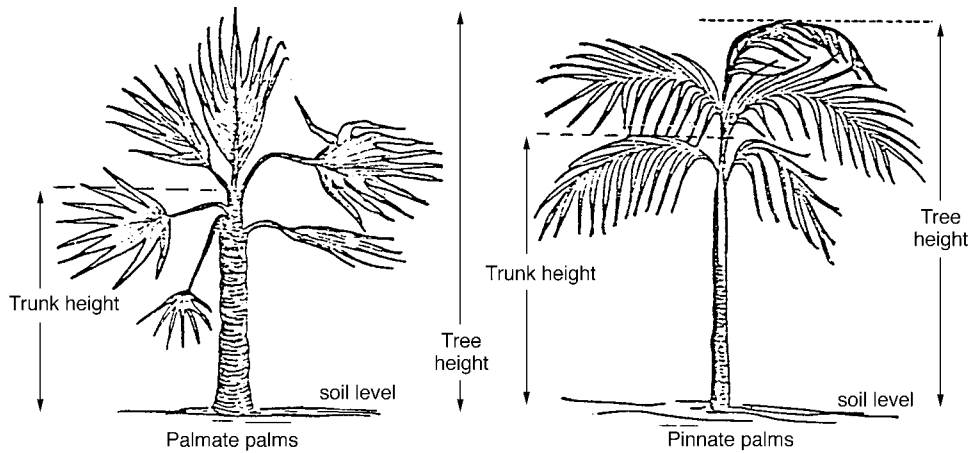

FIGURE 6 – Palms

1.5 Bare root specifications

1.5.1 Nursery grown – spread of roots

Definition: Trees grown in the ground in the nursery without artificial root restriction devices, such as containers or fabric bags, under favorable growing conditions and which have received the proper cultural treatment to develop a well-branched root system. After harvest, the soil is removed from the roots.

Table 5 – Caliper/height/root spread relationship – nursery grown bare root trees

All bare root trees shall have a well-branched root system characteristic of the species. The following table represents the approved minimum root spread for nursery grown shade trees.

Caliper	Average height range	Minimum root spread
½ in.	5 to 6 ft.	12 in.
¾ in.	6 to 8 ft.	16 in.
1 in.	8 to 10 ft.	18 in.
1 ¼ in.	8 to 10 ft.	20 in.
1 ½ in.	10 to 12 ft.	22 in.
1 ¾ in.	10 to 12 ft.	24 in.
2 in.	12 to 14 ft.	28 in.
2 ½ in.	12 to 14 ft.	32 in.
3 in.	14 to 16 ft.	38 in.

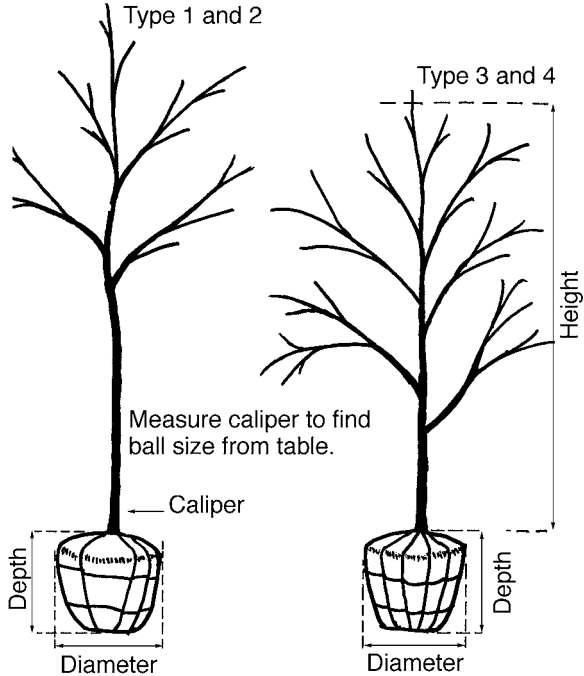

FIGURE 7 – Measurement - Field grown trees

1.5.2 Collected – spread of roots

Trees collected from native stands or established plantings shall be so designated. The spread of root on bare root collected trees shall be 1/3 greater than the spread of roots shown for bare root nursery grown trees (Table 5).

Trees collected from wild or native stands may be considered nursery grown when they have been successfully reestablished in the nursery row and grown under regular nursery cultural practices for a minimum of two growing seasons and have attained adequate root and top growth to indicate full recovery from transplanting into the nursery row.

1.6 Root ball guidelines

1.6.1 Root ball diameters - field grown trees

The following tables represent the recommended minimum root ball sizes for trees that are (a) grown in the ground in the nursery without artificial root restriction devices, such as containers or fabric bags, (b) grown under favorable growing conditions, having received the proper cultural treatment to develop a well branched root system, and (c) harvested with the ball of earth in which they are growing remaining intact (e.g., balled and burlapped).

Many factors affect the minimum root ball size. Although minimum ball size is not a required specification, parties to nursery stock transactions are encouraged to address minimum ball size in personal communications or specification documents prior to the transaction. The objective in all nursery stock transactions is for root balls to meet the following general requirement:

Ball sizes should always be of a diameter and depth to encompass enough of the fibrous and feeding root system as necessary for the full recovery of the plant.

Given the variety of acceptable cultural practices in the industry, the ball sizes set forth in this section are based on those factors which are objectively observable and measurable: the height or caliper measurement. Other cultural practices in the nursery, such as transplanting or root pruning practices or watering techniques, or soil types and local growing conditions, certainly affect the density of the roots, but are much more difficult to observe and measure within the context of the Standard.

It is recognized that plants having a coarse or wide-spreading root system because of natural habit of growth, soil condition, infrequent transplanting practice, or plants that are moved out of season, would require a root ball larger than the recommended size. It is also recognized that there may be circumstances where the sizes recommended may be excessive, such as stock grown in pots or other containers, field plants recently planted out from containers or with smaller balls, or plants which have been frequently transplanted or root pruned.

For example, if root density is of particular importance to a seller, buyer, or specifier, the nursery stock may be designated in marketing materials or in specification documents as being transplanted or root pruned a certain number of times. In such cases, the grower may ship the nursery stock with a root ball size smaller than shown in Table 6. **This approach is intended to assist those members of the trade who recognize the value of enhanced cultural practices in the nursery industry.**

Table 6 – Root ball diameters - field grown trees

Type 1 and Type 2 Shade Trees		Type 3 and Type 4 Small Upright and Small Spreading Trees	
Caliper	Minimum diameter root ball	Height (to 5-6') Caliper (6' and over)	Minimum diameter root ball
½ in.	12 in.	2 ft.	10 in.
¾ in.	14 in.	3 ft.	12 in.
1 in.	16 in.	4 ft.	14 in.
1 ¼ in.	18 in.	5 ft.	16 in.
1 ½ in.	20 in.	¾ in.	16 in.
1 ¾ in.	22 in.	1 in.	18 in.
2 in.	24 in.	1 ¼ in.	19 in.
2 ½ in.	28 in.	1 ½ in.	20 in.
3 in.	32 in.	1 ¾ in.	22 in.
3 ½ in.	38 in.	2 in.	24 in.
4 in.	42 in.	2 ½ in.	28 in.
4 ½ in.	48 in.	3 in.	32 in.
5 in.	54 in.	3 ½ in.	38 in.
5 ½ in.	57 in.	4 in.	42 in.
6 in.	60 in.	4 ½ in.	48 in.
7 in.	70 in.	5 in.	54 in.
8 in.	80 in.	5 ½ in.	57 in.
		6 in.	60 in.
		7 in.	70 in.
		8 in.	80 in.

1.6.2 Trunk in center of root ball

Plants dug to the specifications in the following tables should have the trunk or stem of the plant in the center of the earth ball. A tolerance of 10% of the diameter is the maximum deviation allowable (See Figure 8). For example: For a tree with a 30-inch root ball, the center of the trunk at ground level shall be within a circle 13 ½ inches from the outer edge of the ball.

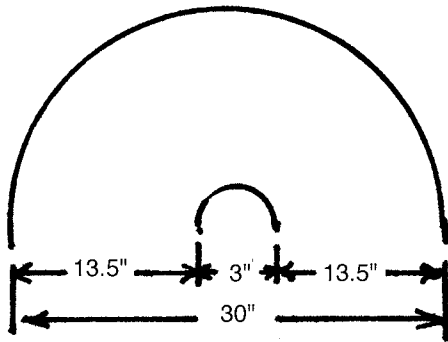

FIGURE 8 – Example: trunk in center of root ball

1.6.3 Root ball depths

Measurement: Depth of the ball is measured from the top of the ball, which in all cases shall begin at the root flare (see Figure 9). Soil above the root flare, from being deeply planted in the nursery as a young plant, as a result of maintenance practices in the nursery, or added during harvest, shall not be included in ball depth measurement, and should be removed.

Under certain soil and regional conditions, plants have root systems of proportionately less depth and greater diameter. These require a more shallow but wider ball to properly encompass the roots. Conversely, in other soils, and in certain regions, roots develop greater depth and less spread, requiring an exceptionally deep ball, which may be smaller in diameter and greater in depth than the size recommended.

For the greater part of the country, ball depths will carry the following ratios:

Balls with diameters less than 20 inches - depth not less than 65% of the diameter of the ball.

Balls with diameters of 20 inches and up - depth not less than 60% of the diameter of the ball.

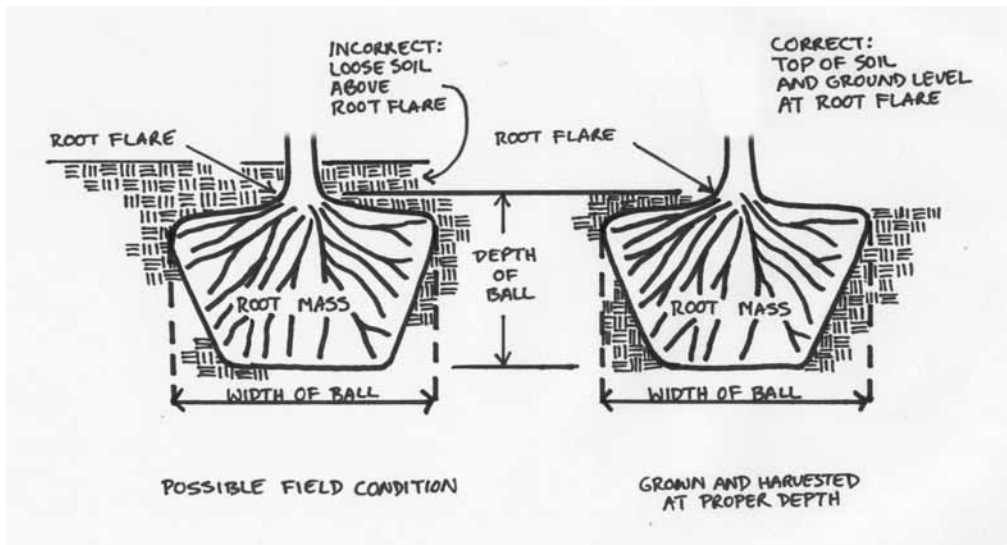

FIGURE 9 – Measurement of root ball depths

1.6.4 Burlapping

Burlap or other suitable material shall be biodegradable and shall completely cover the root ball. This wrapping shall be between the earth ball and the lacing or ball supporting device.

1.6.5 Ball-supporting devices

If used, ball-supporting devices, such as wire baskets, shall hold the ball in a firm, rigid condition.

1.6.6 Collected

Definition: Plants collected from unmanaged land.

It is generally recognized that plants growing in their native state will sustain a much more severe shock when transplanted than the same kinds of plants when nursery grown. If collected material is moved, a considerably larger ball than that recommended for transplanted nursery stock is required, because of the unrestricted root development and the varying conditions of soil in which such material is found.

The minimum ball sizes shall be equal to those specified in Table 6 for the next larger size nursery grown stock.

For the purposes of this Standard, plants collected from wild or native stands may be considered nursery grown when they have been successfully reestablished in the nursery row and grown under regular nursery cultural practices for a minimum of two growing seasons and have attained adequate root and top growth to indicate full recovery from transplanting into the nursery row.

1.6.7 Plantation grown

Definition: Plants that have been systematically planted in fertile, friable soil that is relatively free of stones and foreign matter, but where plants have had a minimum of after-care.

Plantation grown nursery stock shall be so designated. The minimum ball sizes shall be equal to those specified in Table 6 for the next larger size nursery grown stock.

1.6.8 Field potted or field boxed

Field potted plants are field-grown nursery-grown plants, dug with a ball of earth still intact in which they are growing, and which, in lieu of burlapping, are placed in a container to retain the ball unbroken.

The minimum ball sizes shall be equal to those specified in Table 6 for nursery grown stock.

1.6.9 Processed balled

Definition: A processed balled plant is one dug bare root, while dormant, to which a growing medium is mechanically or manually formed around the roots to form a ball.

Table 7 represents the recommended minimum sizes of processed balls for trees processed by machine or by hand.

All trees shall have been grown under favorable growing conditions, having received the proper cultural treatment to develop a well branched root system.

Table 7 – Root ball diameters – processed balled trees

Type 1 and Type 2 Shade Trees		Type 3 and Type 4 Small Upright and Small Spreading Trees	
Caliper	Minimum diameter root ball	Height (to 5-6') Caliper (6' and up)	Minimum diameter root ball
½ in.	10 in.	2 ft.	10 in.
¾ in.	10 in.	3 ft.	10 in.
1 in.	12 in.	4 ft.	12 in.
1 ¼ in.	14 in.	5 ft.	12 in.
1 ½ in.	16 in.	¾ in.	12 in.
1 ¾ in.	18 in.	1 in.	14 in.
2 in.	20 in.	1 ¼ in.	14 in.
2 ½ in.	20 in.	1 ½ in.	14 in.
3 in.	28 in.	1 ¾ in.	18 in.

1.6.10 Use of digging machines

It is recognized that balling of nursery grown stock can be accomplished by hand digging or by mechanical devices especially designed for nursery conditions. The use of digging machines is an acceptable nursery practice.

1.7 Container grown specifications

All specifications for container grown plants shall include **both plant size and container size**. Plant size intervals and reference to height or spread shall be in accordance with the guidelines for the appropriate plant type set forth in Section 1.2 - Types of Trees. Plant size indicates the minimum size allowable in the desired plant size interval. Container size shall be by container classification (i.e., not by container volume) as set forth in the container class table in the Foreword.

In all cases, container grown nursery stock shall meet the following general requirement:

All container grown nursery stock shall be healthy, vigorous, well rooted, and established in the container in which it is growing. Container grown nursery stock shall have a well-established root system reaching the sides of the container to maintain a firm ball when the container is removed, but shall not have excessive root growth encircling the inside of the container.

It is recognized that certain containers may be designed or treated to retard circling roots around the inside of the container, and that they are acceptable in the trade.

The container shall be sufficiently rigid to hold the ball shape and to protect the root mass during shipping.

Table 8 – Container class guidelines – shade and flowering trees

All specifications shall include plant size designation. The container class is a secondary specification that should be determined after the desired plant size is determined. This table is to be used as a guideline in determining which container class designation should accompany the plant size designation. This table should not be used as the basis for rejecting nursery stock based on the minimum or maximum plant size shown in this table in cases where a specification only provides a container class designation. In such cases, the parties should refer to the “general requirement” for all container grown nursery stock (see Section 1.7) to determine whether the root system complies with the Standard.

How to use this table: (1) Identify the appropriate column according to plant type. (2) Identify every row with a plant size range that includes the desired plant size. (3) Specify an appropriate container class in the right-hand column of a row in which the desired plant size falls *between the minimum and maximum* plant size shown. For example, a 2” caliper tree is included as the maximum plant size for a #15 container and would NOT be appropriate. A 2” caliper tree is included as the minimum plant size for a #65 container and would NOT be appropriate. The appropriate container class would be either a #20, #25, or #45, since the 2” caliper plant size falls between the minimum and maximum plant sizes in those ranges. Exceptions to this approach would be for very fast-growing species, in which case the maximum plant size would be an appropriate reference for determining the container class; or for very slow-growing or dwarf varieties, in which case the minimum plant size would be an appropriate reference for determining the container class.

Note: Throughout this Standard, plant size indicates minimum allowable plant size in desired plant size interval (e.g., “1 in. cal.” specification designates size interval from 1-inch caliper up to but not including 1 ¼ -inch caliper).

Types 1 & 2 Shade Trees		Types 3 & 4 Small Upright and Small Spreading Trees		Shrub Form and Multi- stem Trees*		Container Class
Minimum Plant Size (Height/ Caliper)	Maximum Plant Size (Height/ Caliper)	Minimum Plant Size (Height/ Caliper)	Maximum Plant Size (Height/ Caliper)	Minimum Plant Size (Height)	Maximum Plant Size (Height)	
12 in.	4 ft.	12 in.	3 ft.	N/A	N/A	1
2 ft.	6 ft.	18 in.	4 ft.	N/A	N/A	2
3 ft.	6 ft.	2 ½ ft.	6 ft./ 1 in.	2 ft.	5 ft.	3
4 ft.	7 ft.	4 ft.	7 ft./ 1 ¼ in	3 ft.	6 ft.	5
5 ft.	8 ft./1 ¼ in.	5 ft.	1 ½ in.	4 ft.	7 ft.	7
6 ft.	1 ½ in.	6 ft./¾ in.	1 ¾ in.	5 ft.	8 ft.	10
8 ft./¾ in.	2 in.	1 in.	2 in.	6 ft.	10 ft.	15
1 in.	2 ½ in.	1 ¼ in.	2 ½ in.	7 ft.	12 ft.	20
1 ¼ in.	3 in.	1 ½ in.	3 in.	8 ft.	14 ft.	25
1 ¾ in.	3 ½ in.	2 in.	3 ½ in.	10 ft.	16 ft.	45
2 in.	4 in.	2 ½ in.	4 in.	12 ft.	18 ft.	65
2 ½ in.	5 in.	3 in.	5 in.	14 ft.	20 ft.	95/100

*Note: For clump form trees (Section 1.3.2), do not use this column, but use the column appropriate for the Type, and reference the minimum plant size to determine the appropriate container class. For purposes of using this table, the caliper of clump form trees shall be calculated as one-half of the total of the calipers of up to the three largest required trunks.

1.8 Box-grown

It is recognized that many trees are grown and shipped in wooden boxes, and that this is an acceptable practice in the trade. The container class table in the Foreword shows the relationship of wooden box sizes and container classes accepted in the trade, although wooden boxes may have substantially higher soil volumes than the accepted container class equivalent.

1.9 In-ground fabric bag-grown

These specifications are for shade and flowering trees field grown in fabric bags, commonly called grow bags. Fabric bag size specifications are provided in the Foreword.

The following table represents the recommended maximum tree caliper for shade and flowering trees, (Types 1,2,3, and 4), and multi stem trees, grown in in-ground fabric bags.

Table 9 - Fabric bag sizes-trees

Maximum recommended tree caliper	Minimum recommended fabric bag size (diameter)
1 ¼ in.	10 in.
1 ½ in.	12 in.
1 ¾ in.	14 in.
2 in.	16 in.
2 ½ in.	18 in.
3 in.	20 in.
3 ½ in.	22 in.
4 in.	24 in.

Section 2: Deciduous Shrubs

This section applies to plants generally sold to the retail and landscape trade. For liner grades see Section 6.

2.1 Specifications - general

2.1.1 – Required specifications

For **bare root** stock (Section 2.3) and **field grown** stock (Section 2.4), specifications shall include plant size, by spread or height, as appropriate to the plant type (see Section 2.2).

For **container** grown stock (Section 2.5), specifications shall include plant size, by spread or height, as appropriate to the plant type (see Section 2.2), and container class (see Foreword).

For **fabric bag** grown stock (Section 2.6), specifications shall include plant size and minimum fabric bag size.

For **all Type 0 plants**, measurement designation shall include plant size and minimum spread of roots in cases where plants are shipped prior to reaching full growth for that season.

2.1.1.1 Plant size intervals

General practice is for **plant size specification** to express only the minimum for the desired size interval. Each interval includes plants from the minimum plant size up to but not including the next larger size interval. Acceptable size intervals for each plant type are shown in the appropriate plant type sections, below. For instance, a specification for a “12 in.” Type 1 plant references the “12 to 15 inch” spread interval, while a specification for a “12 in.” Type 3 plant references the “12 to 18 inch” height interval (see Section 2.2).

2.1.1.2 Definition of “cane”

For purposes of this Standard, a cane shall be considered a primary stem which starts from the ground or at a point close to the ground at a point not higher than one-fourth the height of the plant, and which reaches the minimum height stated in the plant size specification.

2.1.1.3 Spread and height measurements

Spread measurement shall be the average spread of the branches of the plant, without leaves. Height measurement shall be from the soil line for container grown plants, from the ground for field grown plants, or from the root collar for bare root plants, and shall extend to the top of all canes meeting the height specification, without leaves, in accordance with Table 10, 11, 12, or 13, as appropriate to the plant type. This is generally at a point below the tallest point on the plant. For example, a 3' Type 2 plant should have 5 canes reaching at least 3', even if two or three canes are taller than 3' (see Table 12).

2.1.2 Optional specifications and quality designations

Nursery stock shipped in accordance with the required specifications shall be deemed to be acceptable within the terms of this section if it is typical in size and habit for the species in the region of the country in which it is grown unless specifications include additional details.

Specifiers and buyers are encouraged to provide additional appropriately detailed descriptive language to the extent that required specifications set forth in Section 2.1.1 do not provide sufficient detail for a particular transaction.

2.1.2.1 Minimum number of canes

The illustrations and tables provided in this section show the typical minimum number of canes for each plant size for each plant type. They are intended as guidelines to determine the minimum number of canes generally acceptable in the trade for deciduous shrubs. Specifiers may include the minimum number of canes in a specification if the guidelines shown in this section may be insufficient for a particular transaction.

2.1.2.2 Transplanting or root pruning

Specifications may also include the minimum times that a plant must have been transplanted or root pruned, in which case a root ball size smaller than that shown in the appropriate table in Section 2.2 should also be specified to account for the more well-formed root mass (e.g., "trans. min. 3x, min. 20" ball).

2.1.2.3 Specimen designation

General terms, such as "specimen," or "quality grade," should be avoided in favor of more specific terms that describe the plant attributes required by the specifier or buyer, such as "heavily budded," or "densely branched." The determination of compliance with the term "specimen" shall be determined with reference to the descriptive characteristics provided in the specifier's or buyer's specifications.

2.2 Types of deciduous shrubs

Other than Type 0 plants, plant types are determined by the size of the plant at maturity, assuming full winter hardiness in the region in which the plant is grown.

2.2.1 Type 0 – Tender shrubs

Definition: Plants having a tendency not to produce top growth that is fully winter hardy in certain parts of the country. It is general practice to prune to the ground or to live wood due to partial or complete die-back. Many types of plants may have various degrees of persistence in the woody stems in different parts of the country, and would not be included as Type 0 plants in regions where stems reach maturity without significant die-back each year. In some cases these plants are referred to as "woody perennials."

Examples: *Buddleia*, *Caesalpinia pulcherrima*, *Caryopteris*, *Hydrangea macrophylla*, *H. arborescens*, *Vitex*.

Measurement: Plant size (top growth) measurement may be by height or spread, whichever is greater, using three-inch intervals through 15-18”, then six-inch intervals through 30-36”, then one foot intervals from 3-4’ and up.

Plants may not meet plant size designation at time of shipment at certain times of the year, but would be expected to reach plant size designation during the first growing season after shipment. In cases where plants may be shipped after being pruned back and before reaching plant size designation, specifications shall include minimum spread of roots. Spread of roots shall be stated in two-inch increments.

Table 10 – Height or spread relationship to number of canes and spread of roots or root ball diameter – Type 0 deciduous shrubs

See Figure 10 for sample graphic representation.

Height or spread (full seasonal growth)	Minimum number of canes (full seasonal growth)	Minimum spread of roots or root ball diameter
6 in.	2	3 in.
9 in.	2	4 in.
12 in.	3	5 in.
15 in.	3	7 in.
18 in.	4	9 in.
24 in.	4	11 in.
30 in.	5	13 in.

2.2.2 Type 1 – Small or dwarf

Definition: Plants that typically do not grow to a mature height or spread exceeding three feet.

Examples: *Berberis thunbergii* ‘Crimson Pygmy,’ *Cotoneaster apiculata*, *C. dameri* ‘Coral Beauty,’ *C. horizontalis*, *Cytisus prostrata*, *Deutzia gracilis* ‘nikko,’ *Forsythia* ‘Arnold Dwarf,’ *F. x bronxensis*, *F. x Gold Tide*, *Fothergilla* ‘Blue Mist,’ *Genista pilosa*, *Itea virginica* Little Henry, *Salix prostrata*, *Spiraea japonica* ‘alpina,’ *S.* ‘Gold Mound,’ *S.* ‘Little Princess,’ *Symphoricarpos x chenaulti*, *Viburnum opulus nanum*, *Weigela floribunda* ‘Minuet’

Measurement: Measurement indicates height or spread, whichever is greater, using three-inch intervals through 15-18”, then six-inch intervals through 30-36”.

Table 11 – Height or spread relationship to number of canes and spread of roots or root ball diameter – Type 1 deciduous shrubs

See Figure 10 for sample graphic representation.

Height or spread	Minimum number of canes	Minimum spread of roots or root ball diameter
6 in.	3	4 in.
9 in.	3	6 in.
12 in.	4	8 in.
15 in.	4	9 in.
18 in.	5	10 in.
24 in.	5	11 in.
30 in.	6	12 in.

2.2.3 Type 2 - Intermediate

Definition: Plants that typically mature at a height or spread from three feet up to seven feet.

Examples: *Azalea x (exbury, mollis hybrids)*, *Chaenomeles japonica*, *Cornus sericea*, *Cotoneaster devaricata*, *Euonymus alata ‘Compacta,’* *Fothergilla ‘Mount Airy,’* *Lagerstroemia indica ‘Victor,’* *Potentilla fruticosa*, *Spiraea x bumalda ‘Froebelii,’* *S. nipponica ‘Snowmound,’* *S. x vanhouttei*, *Viburnum carlesii*, *V.juddi*, *Weigela floribunda* *Wine & Roses, ‘Vanicek,’* *W. florida ‘Java Red’*

Measurement: Measurement indicates height, using three-inch intervals through 3-6”, then six-inch intervals through 18-24”, then one-foot intervals from 2-3’through 6-7’.

Table 12 – Height or spread relationship to number of canes and spread of roots or root ball diameter – Type 2 deciduous shrubs

See Figure 11 for sample graphic representation.

Height or spread	Minimum number of canes	Minimum spread of roots or root ball diameter
6 in.	3	6 in.
12 in.	3	8 in.
18 in.	4	10 in.
2 ft.	4	12 in.
3 ft.	5	14 in.
4 ft.	5	18 in.
5 ft.	6	24 in.
6 ft.	6	30 in.

2.2.4 Type 3 – Large or tall

Definition: Plants that grow to a mature height exceeding seven feet.

Examples: *Amelanchier laevis*, *Cornus racemosa*, *Forsythia* (tall varieties), *Hamamelis virginiana*, *Ilex verticillata*, *Ligustrum* (tall varieties), *Physocarpus*, *Syringa* ‘Madame Lemoine,’ *Viburnum opulus*, *V. lantana*, *V. plicatum*, *Weigela floribunda* ‘Eva Radke’

Measurement: Measurement indicates height, using three-inch intervals through 3-6”, then six-inch intervals through 18-24”, then one-foot intervals through 5-6’, then two-foot intervals from 6-8’ and up.

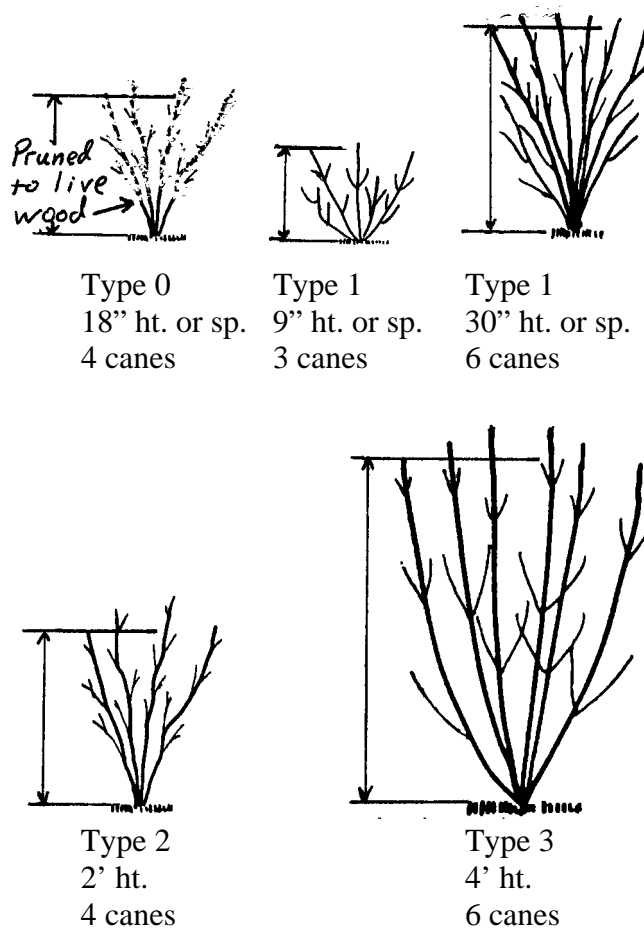

FIGURE 10 – Types of Deciduous Shrubs

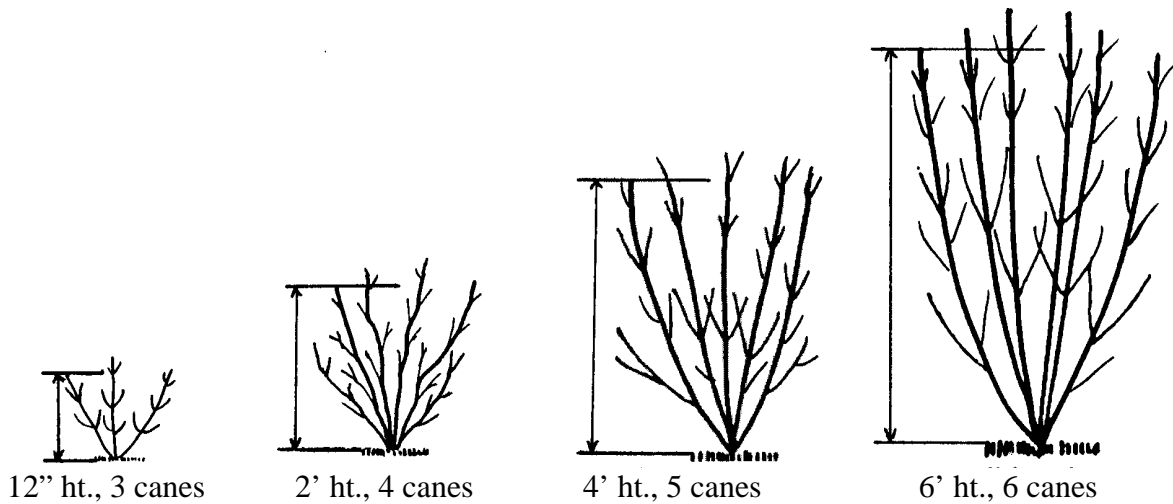

FIGURE 11 – Typical Type 2 Intermediate Deciduous Shrubs

Table 13 – Height or spread relationship to number of canes and spread of roots or root ball diameter – Type 3 deciduous shrubs

See Figure 10 for sample graphic representation.

Height or spread	Minimum number of canes*	Minimum spread of roots or root ball diameter*
12 in.	3	8 in.
18 in.	4	10 in.
2 ft.	5	12 in.
3 ft.	5	16 in.
4 ft.	6	20 in.
5 ft.	6	24 in.
6 ft.	7	30 in.
8 ft.	8	36 in.
10 ft.	9	44 in.
12 ft.	10	52 in.

*Note: Deciduous shrubs with a narrow habit may have significantly fewer canes and significantly smaller spread of harvested roots than shown in the table. Some varieties may be most desirable with single canes, regardless of height. *Examples: Cornus alternifolia, Syringa vulgaris, Viburnum lentago.*

2.3 Bare root specifications

2.3.1 Nursery grown—spread of roots

Definition: Nursery grown deciduous shrubs that are being grown in the ground in the nursery without artificial root restriction devices, such as containers or fabric bags, under favorable growing conditions and which have received the proper cultural treatment to develop a well branched root system. After harvest, the soil is removed from the roots.

Nursery grown bare-root shrubs shall have a well-branched root system characteristic of the species. Bare root shrubs shall have minimum root spreads as shown in the tables in Section 2.2, above, for the appropriate plant type.

2.3.2 Collected—spread of roots

Shrubs collected from native stands or established plantings shall be so designated. The spread of roots, bare root collected, shall be one-third greater than the spread of roots of nursery grown shrubs.

For the purposes of this standard, shrubs collected from wild or native stands may be considered nursery grown when they have been successfully reestablished in the nursery row and grown under regular nursery cultural practices for a minimum of two growing seasons and have attained adequate root and top growth to indicate full recovery from transplanting into the nursery row.

2.4 Root ball guidelines

2.4.1 Root ball diameters – field grown deciduous shrubs

Definition: Field grown shrubs that are being grown in the ground in the nursery without artificial root restriction devices, such as containers or fabric bags, under favorable growing conditions and which have received the proper cultural treatment to develop a well-branched root system.

Minimum diameters: Field grown shrubs shall have root balls of a diameter that meet minimum spread of roots guidelines shown in the tables in Section 2.2, above, for the appropriate plant type. Field grown plants are harvested with the ball of earth in which they are growing remaining intact.

Many factors affect the minimum root ball size. Although minimum ball size is not a required specification, parties to nursery stock transactions are encouraged to address minimum ball size in personal communications or specification documents prior to the transaction. The objective in all nursery stock transactions is for root balls to meet the following general requirement:

Ball sizes should always be of a diameter and depth to encompass enough of the fibrous and feeding root system as necessary for the full recovery of the plant.

Given the variety of acceptable cultural practices in the industry, the ball sizes set forth in this section are based on those factors which are objectively observable and measurable: the spread or height measurement. Other cultural practices in the nursery, such as transplanting or root pruning practices or watering techniques, or soil types and local growing conditions, certainly affect the density of the roots, but are much more difficult to observe and measure within the context of the Standard.

It is recognized that plants having a coarse or wide-spreading root system because of natural habit of growth, soil condition, infrequent transplanting practice, or plants that are moved out of season, would require a root ball larger than the recommended size. It is also recognized that there may be circumstances where the sizes recommended may be excessive, such as stock grown in pots or other containers, field plants recently planted out from containers or with smaller balls, or plants which have been frequently transplanted or root pruned.

For example, if root density is of particular importance to a seller, buyer, or specifier, the nursery stock may be designated in marketing materials or in specification documents as being transplanted or root pruned a certain number of times. In such cases, the grower may ship the nursery stock with a root ball size smaller than shown in the appropriate tables in this section. **This approach is intended to assist those members of the trade who recognize the value of enhanced cultural practices in the nursery industry.**

2.4.2 Plant in center of root ball

Plants dug to the specifications in Tables 10 through 13 should have the trunk or stem of the plant in the center of the earth ball. A tolerance of 10% of the diameter is the maximum deviation allowable.

Example: For a shrub with a 20-inch root ball, the center of the plant at ground level shall be within a circle 9 inches from the outer edge of the ball.

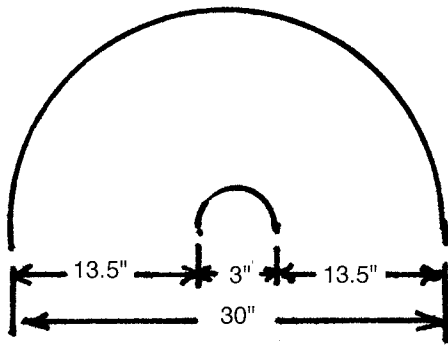

FIGURE 12 – Center of Plant in Center of Root Ball

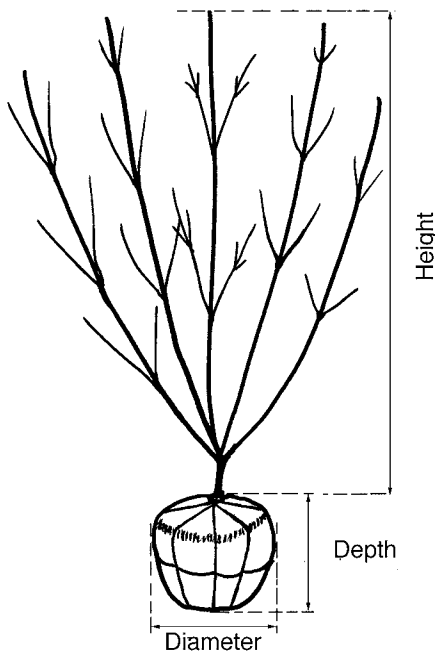

FIGURE 13 – Measurement of Field Grown Deciduous Shrubs

2.4.3 Root ball depths

Measurement: Depth of the ball is measured from the top of the ball, which in all cases shall begin at the root flare (See Figure 14). Soil above the root flare, from being deeply planted in the nursery as a young plant, as a result of maintenance practices in the nursery, or added during harvest, shall not be included in ball depth measurement.

Under certain soil and regional conditions, plants have root systems of proportionately less depth and greater diameter. These require a more shallow but wider ball to properly encompass the roots. Conversely, in other soils and in certain regions roots develop greater depth and less spread, requiring an exceptionally deep ball, unless it has been demonstrated to the purchaser or his representative that the plants have been root pruned or undercut.

For the greater part of the country ball depths will carry the following ratios:

Balls with diameters less than 20 inches—depth not less than 65% of diameter.

Balls with diameters of 20 inches or more—depth not less than 60% of the diameter.

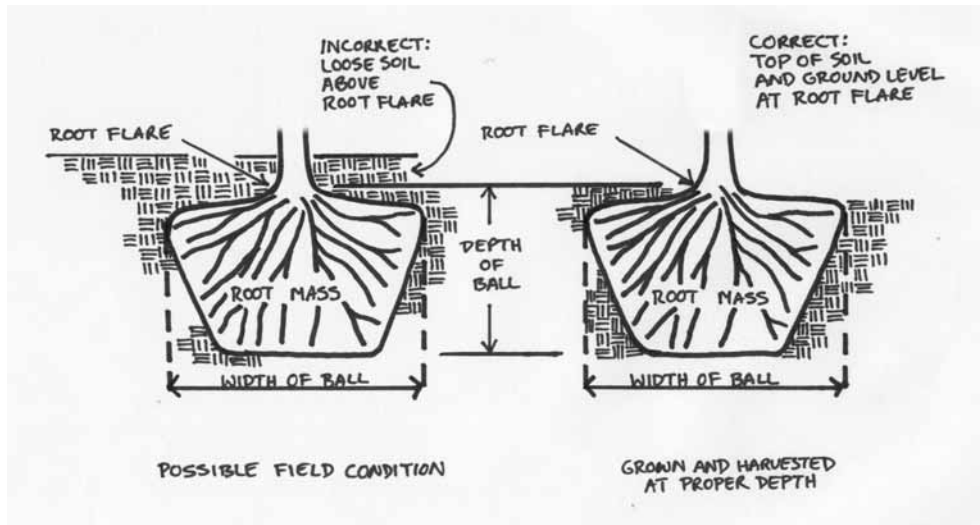

FIGURE 14 – Ball Depths: Field Grown Deciduous Shrubs

2.4.4 Burlapping

Burlap or other suitable material shall be biodegradable and shall completely cover the root ball. This wrapping shall be between the earth ball and the lacing or ball supporting device.

2.4.5 Ball supporting devices

If used, ball supporting devices, such as wire baskets, shall hold the ball in a firm, rigid condition.

2.4.6 Field potted plants

Definition: Balled and potted plants are field-grown nursery plants, dug with a ball of earth still intact in which they are growing, and which, in lieu of burlapping, are placed in a container to retain the ball unbroken.

The minimum ball sizes shall be equal to the spread of roots specified in the appropriate table in Section 2.2, above, for nursery grown stock.

2.4.7 Processed balled plants

Definition: A processed balled deciduous shrub is one dug bare root, while dormant, and a growing medium is mechanically placed around the roots to form a ball, then held in place with a ball supporting device.

The minimum ball sizes shall be equal to the spread of roots specified in the appropriate table in Section 2.2, above, for nursery grown stock.

2.4.8 Collected plants

Definition: Plants collected from unmanaged land.

Collected (Coll.) shall be so designated. It is generally recognized that plants growing on unmanaged land will sustain a much more severe shock when transplanted than the same kinds of plants when nursery grown. If collected material is moved, a considerably larger ball than that recommended for transplanted nursery stock is required, because of the unrestricted root development and the varying conditions of soil in which such material is found.

The minimum ball sizes shall be equal to the spread of roots specified in the appropriate table in Section 2.2, above, for the next larger size nursery grown stock.

For the purposes of this Standard, plants collected from wild or native stands may be considered nursery grown when they have been successfully reestablished in the nursery row and grown under regular nursery cultural practices for a minimum of two growing seasons and have attained adequate root and top growth to indicate full recovery from transplanting into the nursery row.

2.4.9 Plantation grown plants

Definition: Plants that have been systematically planted in fertile, friable soil which is relatively free of stones and foreign matter, but where plants have had a minimum of after-care.

Plantation grown (Plan.) shall be so designated. The minimum ball sizes shall be equal to the spread of roots specified in the appropriate table in Section 2.2, above, for the next larger size nursery grown stock.

2.4.10 Use of digging machines

It is recognized that balling of nursery grown stock can be accomplished by hand digging or by mechanical devices especially designed for nursery conditions. The use of digging machines is an acceptable nursery practice.

2.5 Container grown specifications

All specifications for container grown plants shall include **both plant size and container size**. Plant size intervals and reference to height or spread shall be in accordance with the guidelines for the appropriate plant type set forth in Section 2.2 Types of Deciduous Shrubs. Container size shall be by container classification (i.e., not by container volume) as set forth in the Container Class Table in the Foreword.

In all cases, container grown nursery stock shall meet the following general requirement:

All container grown nursery stock shall be healthy, vigorous, well rooted, and established in the container in which it is growing. Container grown nursery stock shall have a well-established root system reaching the sides of the container to maintain a firm ball when the container is removed, but shall not have excessive root growth encircling the inside of the container.

It is recognized that certain containers may be designed or treated to retard circling roots around the inside of the container, and that they are acceptable in the trade.

The container shall be sufficiently rigid to hold the ball shape and to protect the root mass during shipping.

Table 14 – Container class guidelines - deciduous shrubs

All specifications shall include plant size designation. The container class is a secondary specification that should be determined after the desired plant size is determined. This table is to be used as a guideline in determining which container class designation should accompany the plant size designation. This table should not be used as the basis for rejecting nursery stock in cases where a specification only provides a container class designation. In such cases, the parties should refer to the “general requirement” for all container grown nursery stock, above, to determine whether the root system complies with the Standard.

How to use this table: (1) Identify the appropriate column according to plant type. (2) Identify every row with a plant size range that includes the desired plant size. (3) Specify an appropriate container class in the right-hand column of a row in which the desired plant size falls *between the minimum and maximum* plant size shown. For example, a 24”ht. Type 2 plant is included as the maximum plant size for a #3 container and would NOT be appropriate. A 24” ht. Type 2 plant is included as the minimum plant size for a #7 container and would NOT be appropriate. The appropriate container class would be a #5, since the 24” ht. plant size falls between the minimum and maximum plant sizes in that range. Exceptions to this approach would be for very fast-growing species, in which case the maximum plant size would be an appropriate reference for determining the container class; or for very slow-growing or dwarf varieties, in which case the minimum plant size would be an appropriate reference for determining the container class.

Note: Throughout this Standard, plant size indicates minimum allowable plant size in plant size range (e.g., “12 in. sp.” specification designates size range from 12-inch spread up to but not including 15-inch spread).

Type 0 and Type 1 Measurement designates greater of height or spread		Type 2 Measurement designates height		Type 3 Measurement designates height		Container Class
Min. Plant Size	Max. Plant Size	Min. Plant Size	Max. Plant Size	Min. Plant Size	Max. Plant Size	
3 in.	15 in.	6 in.	15 in.	6 in.	15 in.	1
6 in.	18 in.	12 in.	18 in.	15 in.	24 in.	2
9 in.	24 in.	15 in.	24 in.	18 in.	30 in.	3
12 in.	3 ft.	18 in.	3 ft.	24 in.	4 ft.	5
		24 in.	4 ft.	30 in.	5 ft.	7
		3 ft.	6 ft.	3 ft.	7 ft.	10
		4 ft.	8 ft.	4 ft.	10 ft.	15
				5 ft.	12 ft.	25
				7 ft.	14 ft.	45
				10 ft.	14 ft.	65
				12 ft.	14 ft.	100

*NOTE: Type 0 plants are shown at full growth at end of growing season. In cases where Type 0 plants have been pruned for rejuvenation, measurement should be by spread of roots in 2-inch increments rather than by the height of the plant.

2.6 In-ground fabric bag-grown

These specifications are for deciduous shrubs field grown in fabric bags, commonly called grow bags. Fabric bag size specifications are provided in the Foreword.

The following table represents the recommended maximum height for deciduous shrubs, grown in in-ground fabric bags.

Table 15—Fabric bag sizes—deciduous shrubs

Maximum shrub height	Minimum recommended fabric bag size
3 ft.	10 in.
4 ft.	12 in.
5 ft.	14 in.
6 ft.	16 in.
8 ft.	18 in.
10 ft.	22 in.
12 ft.	24 in.

Section 3: Coniferous Evergreens

This section applies to plants generally sold to the retail and landscape trade. For lining out stock, see Section 6.

3.1 Specifications - general

3.1.1 – Required specifications

For **field grown** stock (Section 3.3), specifications shall include plant size, by spread or height, as appropriate to the plant type, and shearing designation.

For **container** grown stock (Section 3.4), specifications shall include plant size, by spread or height, as appropriate to the plant type, shearing designation, and container class.

For **fabric bag** grown stock (Section 3.5), specifications shall include plant size, by spread or height, as appropriate to the plant type, shearing designation, and minimum fabric bag size.

If a specification does not include a shearing designation, nursery stock fitting the definition of any shearing designation, except altered form, shall be deemed as acceptable within the terms of this section (See Section 3.1.2).

3.1.1.1 Plant size intervals

General practice is for a **plant size specification** to express only the minimum for the desired size interval. Each interval includes plants from the minimum plant size up to but not including the next larger size interval. Acceptable size intervals for each plant type are shown in the appropriate plant type sections, below. For instance, a specification for a “12 in.” Type 2 plant references the “12 to 15 inch” spread interval, while a specification for an “18 in.” Type 3 plant references the “18 to 24 inch” height interval (see Section 3.2).

3.1.1.2 Spread and height measurements

Spread measurement shall not be taken at the tips of the outermost whorls, but should be an average (see Figure 15). Height measurement shall not be taken at the tip of the leader, but should be taken at the midpoint between the uppermost whorl(s) and the tip of the leader (see Figure 18).

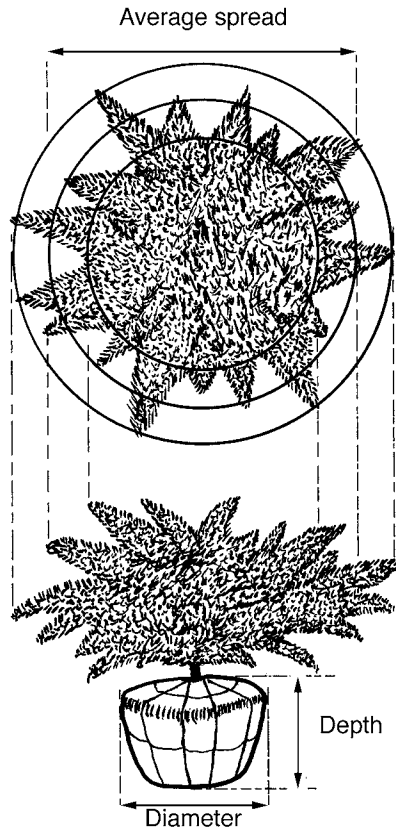

FIGURE 15 – Measurement – Types 1 and 2 coniferous evergreens

3.1.2 Shearing designations

Natural – plant grown with only corrective or reparative pruning, leaving the form that is natural for the species. Never sheared. Specify as “N” (e.g., “Picea abies, N, 4’, B&B or #7”).

Semi sheared or lightly sheared – symmetrically sheared, pruned, or disbudded when the plant is young and then only periodically thereafter during the life of the plant. The intent is to retain an intermediate level of density while retaining the form that is natural for the species and not limiting the height of the plant over a period of time. Trunk caliper shall not be significantly larger than the trunk caliper of a plant that has been allowed to grow as a natural form, defined above. Specify as “LS.”

Sheared – annually or semi-annually sheared, pruned, or disbudded to retain a symmetrical shape, make the plant very dense, and limit the height and width of the plant over a period of time. The trunk caliper of the plant will therefore continue to increase at a disproportionate rate to the plant size, and will be larger than the trunk caliper of a plant that has been allowed to grow naturally. Specify as “S.”

Altered form – sheared or pruned to attain a shape or branching habit that is not natural for the species, such as topiary, espalier, trained with wire, etc. Specifications should include minimum root ball size or container class.

3.1.3 – Determining root ball, container, or fabric bag size

For **natural or semi-sheared** conifers, root ball size shall be determined in accordance with Table 20, and container size shall be determined in accordance with Table 21, below.

For **sheared** form conifers, the following language shall apply:

Where it has been a cultural practice to shear, prune, disbud or otherwise impede the natural growth rate of this group of plants, other than by root pruning, caliper measurement shall be used to determine the minimum ball size.

Measurement of trunk diameter of sheared conifers shall be made in the manner set forth for Shade and Flowering Trees (see Section 1.1.1.2). In those cases where branches interfere with caliper measurement, caliper shall be taken just above, and as near to, the six inch or 12 inch location on the trunk as practicable.

Minimum ball diameter, container class, and fabric bag size for sheared conifers shall be those established in Section 1 for Types 1 and 2 Shade Trees (see appropriate Table 6, table 8, or Table 9), with caliper taking precedence over height in all cases where caliper is shown. Ball depths for sheared plants shall also be established as in Section 1.6.1.

3.1.4 Optional specifications and quality designations

Nursery stock shipped in accordance with the required specifications shall be deemed to be acceptable within the terms of this section if it is typical in size and habit for the species in the region of the country in which it is grown unless specifications include additional details. Specifiers and buyers are encouraged to provide additional appropriately detailed descriptive language to the extent that required specifications set forth in Section 3.1.1 do not provide sufficient detail for a particular transaction.

3.1.4.1 Height and spread

If only height or spread shall be specified, both height and spread may be specified.

3.1.4.2 Transplanting or root pruning

In certain landscapes, such as container plantings with limited soil availability, or when the buyer desires a particularly well-formed root mass, specifications should include the minimum number of times that nursery stock must have been transplanted (e.g., “trans. 3x”). In such cases, nursery stock may be shipped with a root ball smaller than that shown in Table 20, and the smaller root ball may be specified. Root ball sizes in Table 20 are based on trees that have not been transplanted after they have been lined out in the field, which is a typical and accepted practice in the industry.

3.1.4.3 Specimen or quality grade designation, collected stock

General terms, such as “specimen,” or “quality grade,” should be avoided in favor of more specific terms that describe the plant attributes required by the specifier or buyer, such as “symmetrical,” “extra heavy branching,” “matching,” or “single leader.” The determination of compliance with the term “specimen” shall be determined with reference to the descriptive characteristics provided by the specifier or buyer.

Collected stock (Coll.), natural seedling plants dug from native stands or forest plantings, shall be so designated (see Section 3.3.2).

3.1.4.4 Minimum or maximum caliper

In addition to the required height or spread designation, specifications may include minimum or maximum calipers to limit root ball size, and sellers may include minimum or maximum calipers within size intervals in inventory and marketing materials.

3.1.5 Dwarf conifers

Dwarf varieties are not treated as a separate plant type for purposes of this section. They should be specified within the appropriate plant types shown in Section 3.2, below, in accordance with the natural habit of the particular cultivar.

3.2 Types of conifers

3.2.1 Type 1 - Creeping or prostrate

Definition: Plants that generally do not exceed three feet in height at maturity, with spread increasing over time with little or no increase in height. Tall plants with a weeping habit should not be included in this plant type.

Examples: *Juniperus horizontalis* cultivars, *Juniperus chinensis* var. *procumbens*, *Juniperus communis* 'Repanda'

Measurement: Measurement indicates spread (height not considered), using three-inch intervals through 15-18”, then six-inch intervals through 42-48”, then one-foot intervals from 4-5’ and up.

Measurement should be the average of the plant and not the greatest diameter. Plants properly trimmed and transplanted should measure the same in any direction. If a plant is uneven, for example, 15 inches the widest and nine inches the narrowest, it should be classified as 12-in. stock.

3.2.2 Type 2 - Semi-spreading

Definition: Height will be less than spread (less than a ratio of 1:1). Height will be at least one-half the spread up to 30-36” spread; the height will remain less than the spread thereafter, varying somewhat according to natural growth of the particular species and method of handling.

Examples: *Juniperus chinensis* 'Pfitzerana,' *J. sabina* cultivars, *Picea abies* 'Nidiformis,' *Taxus media* 'Densiformis'

Measurement: Measurement indicates spread (height not considered), using three-inch intervals through 15-18", then six-inch intervals through 42-48", then one-foot intervals from 4-5' and up.

Measurement should be the average of the plant and not the greatest diameter. Plants properly trimmed and transplanted should measure the same in any direction. If a plant is uneven, for example, 15 inches the widest and nine inches the narrowest, it should be classified as 12-in. stock.

3.2.3 Type 3 - Broad spreading, globe, and compact upright

Definition: Spread will usually be equal to height up to 12-15" spread. Thereafter, the relation of height to spread will vary somewhat according to natural growth of the particular species and method of handling as these plants mature, but height to spread ratio should never exceed 2:1 (see Table 16, below).

Upright growing dwarf types may approach the minimum dimensions above.

Many broad spreading and globe types included in this classification will have the same or greater spread as height, even in the larger sizes.

Examples: *Chamaecyparis obtusa* 'Gracillis,' 'Nana,' *C. pisifera* 'Plumosa Nana,' 'Squarrosa Minima,' *C. thyoides* 'Heather Bun,' *Juniperus chinensi* 'Blaauw,' *Juniperus squamata* 'Meyeri,' *Juniperus virginiana* 'Globosa,' *Picea pungens* 'Globosa,' *Pinus mugo* 'Pumilio,' *Taxus media* 'Brownii,' *Thuja occidentalis* 'Globosa,' 'Little Gem,' 'Hoveyi,' 'Compacta,' 'Woodwardii,' 'Hetz Midget,' 'Danica,' 'Little Giant,' 'Holmstrup,' *T. orientalis* 'Goldbush'

Measurement: Measurement indicates height (spread not considered), using three-inch intervals through 15-18", then six-inch intervals through 42-48", then one-foot intervals from 4-5' and up.

Measurement should be the average of the plant and not the greatest diameter. Plants properly trimmed and transplanted should measure the same in any direction. If a plant is uneven, for example, 15 inches the widest and nine inches the narrowest, it should be classified as 12-in. stock.

Table 16–Type 3 coniferous evergreens

Height	Minimum spread
6 in.	6 in.
9 in.	9 in.
12 in.	10 in.
15 in.	12 in.
18 in.	15 in.
24 in.	18 in.
30 in.	21 in.
36 in.	24 in.

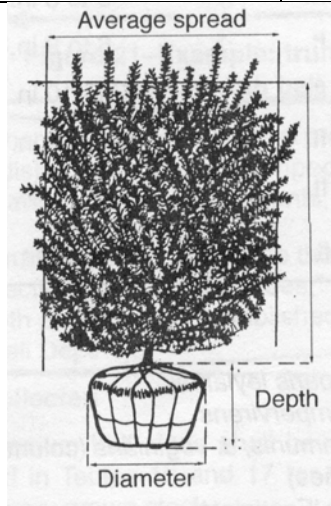

Height:spread ratio of younger plants may be 1:1, then height will be more than spread as plant matures, but height:spread ratio should never be more than 2:1

FIGURE 16 – Measurement – Type 3 coniferous evergreens

3.2.4 Type 4 - Cone type (pyramidal)

Definition: The ratio of height to spread of properly grown material should not be less than 5:3 (see Table 17, below).

Table 17–Type 4 coniferous evergreens

Height	Maximum spread
12 in.	8 to 12 in.
15 in.	9 to 15 in.
18 in.	12 to 18 in.
24 in.	15 to 21 in.
30 in.	18 to 24 in.
3 ft.	21 to 30 in.
4 ft.	30 to 36 in.
5 ft.	3 to 4 ft.

Examples: *Abies*, *A. concolor*, *Cedrus deodara*, *Chamaecyparis pisifera* and varieties (except dwarf types), *Picea abies* (conical types), *P. glauca*, *P. pungens*, *Pinus* (except dwarf types), *Pseudotsuga menziesii*, *Taxus cuspidata* ‘Capitata,’ *Thuja occidentalis*, *T. orientalis* (conical types), *Tsuga canadensis*, *T. caroliniana*, *T. heterophylla*

Measurement: Measurement indicates height, using three-inch intervals through 15-18”, then six-inch intervals through 30-36”, then one-foot intervals through 9-10’, then two-foot intervals from 10-12’ and up.

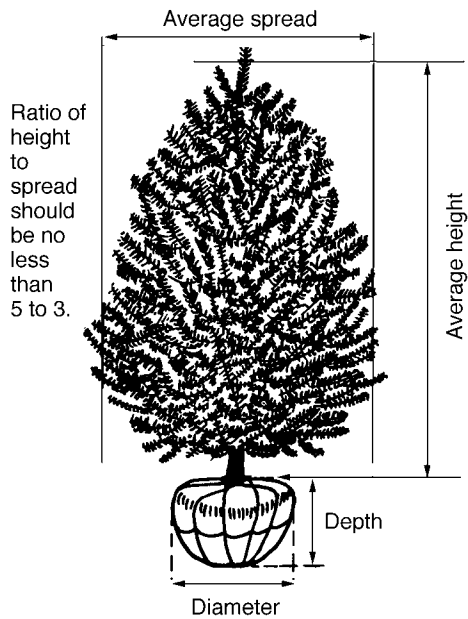

FIGURE 17 – Measurement – Type 4 coniferous evergreens

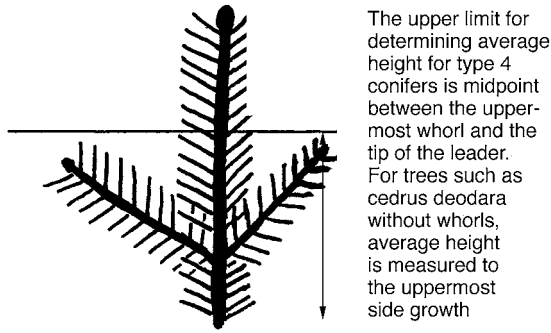

FIGURE 18 – Determining average height – Type 4 coniferous evergreens

3.2.5 Type 5 - Broad upright

Definition: This group includes the broader, upright growing evergreens which develop a straight sided form with many upright branches or “leaders.”

The ratio of height to spread of properly grown material should not be less than 2:1.

Measurement: Measurement indicates height, using three-inch intervals through 15-18”, then six-inch intervals through 30-36”, then one-foot intervals through 9-10’, then two-foot intervals from 10-12’ and up.

Table 18–Type 5 coniferous evergreens

Height	Maximum spread
12 in.	8 to 12 in.
15 in.	9 to 15 in.
18 in.	12 to 18 in.
24 in.	15 to 21 in.
30 in.	18 to 24 in.
3 ft.	21 to 30 in.
4 ft.	30 to 36 in.
5 ft.	3 to 4 ft.

Examples: *Chamaecyparis lawsoniana* ‘Allumii,’ *C. pisifera* ‘Filifera,’ *Juniperus chinensis* ‘Keteleeri,’ ‘Mountbatten,’ *J. scopulorum* ‘Wichata Blue,’ *Taxus media* ‘Hicksii,’ ‘Hatfieldii,’ *Thuja occidentalis* ‘Wareana’

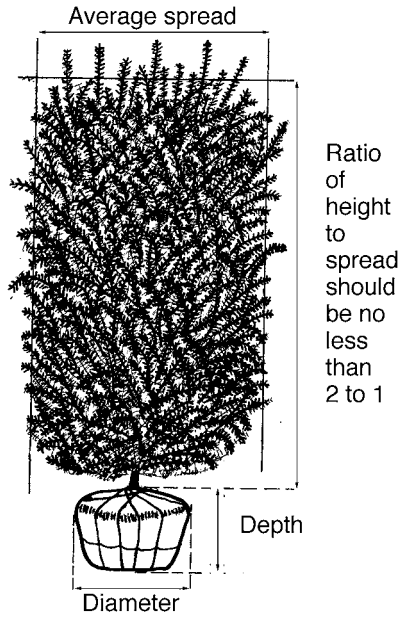

FIGURE 19 – Measurement - Type 5 coniferous evergreens

3.2.6 Type 6 - Columnar type

Definition: This group includes the upright growing evergreens which naturally develop a straight sided form or one that tapers only slightly from the ground to a point more than half the height.

The broader types will usually have a ratio of height to spread of 4 to 1. Many forms, however, will not attain this ratio, and even those of broad habit may be trimmed to advantage into a narrowed form. However, in most cases the ratio of height to spread should be less than 5 to 1.

Measurement: Measurement indicates height, using three-inch intervals through 15-18", then six-inch intervals through 30-36", then one-foot intervals through 9-10', then two-foot intervals from 10-12 and up.

Table 19–Type 6 coniferous evergreens

Height	Maximum spread
12 in.	3 to 6 in.
15 in.	4 to 7 in.
18 in.	5 to 8 in.
24 in.	6 to 9 in.
30 in.	7 to 10 in.

3 ft.	9 to 12 in.
4 ft.	12 to 15 in.
5 ft.	15 to 18 in.
6 ft.	18 to 21 in.
7 ft.	21 to 24 in.
8 ft.	24 to 30 in.

Examples: *x Cupressocyparis leylandii*, *Cupressus sempervirens*, *Juniperus communis* *Suecica*, *J. virginiana* (columnar type varieties), *Taxus baccata* 'Fastigiata,' *Thuja occidentalis* 'Smaragd,' *T. orientalis* (columnar type varieties)

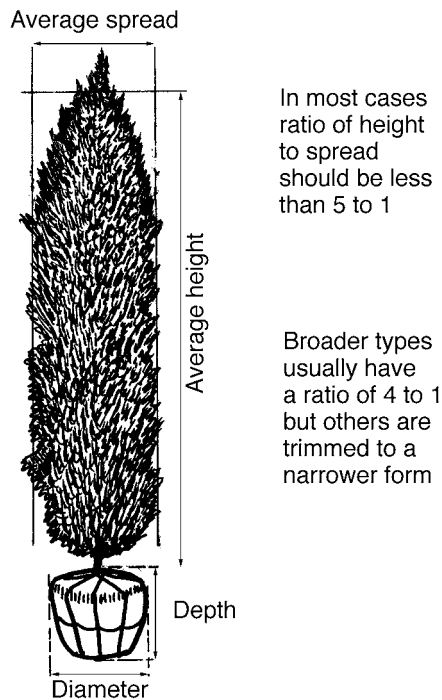

FIGURE 20 – Measurement – Type 6 coniferous evergreens

3.3 Root ball guidelines

3.3.1 Root ball diameters - field grown coniferous evergreens

Table 20, below, represents the recommended minimum root ball diameters for conifers which are being grown in the ground in the nursery without artificial root restriction devices, such as containers or fabric bags, under favorable growing conditions and which have received the proper cultural treatment to develop a well branched root system.

These specifications are for plants harvested with the ball of earth in which they are growing remaining intact.

Many factors affect the minimum root ball size. Although minimum ball size is not a required specification, parties to nursery stock transactions are encouraged to address minimum ball size in personal communications or specification documents prior to the transaction. The objective in all nursery stock transactions is for root balls to meet the following general requirement:

Ball sizes should always be of a diameter and depth to encompass enough of the fibrous and feeding root system as necessary for the full recovery of the plant.

Given the variety of acceptable cultural practices in the industry, the ball sizes set forth in this section are based on those factors which are objectively observable and measurable: the spread or height of the plant, and the caliper of the trunk in cases where the size of the plant has been controlled through shearing techniques. Other cultural practices in the nursery, such as transplanting or root pruning practices or watering techniques, or soil types and local growing conditions, certainly affect the density of the roots, but are much more difficult to observe and measure within the context of the Standard.

It is recognized that plants having a coarse or wide-spreading root system because of natural habit of growth, soil condition, infrequent transplanting practice, or plants that are moved out of season, would require a root ball larger than the recommended size. It is also recognized that there may be circumstances where the sizes recommended may be excessive, such as stock grown in pots or other containers, field plants recently planted out from containers or with smaller balls, or plants which have been frequently transplanted or root pruned.

For example, if root density is of particular importance to a seller, buyer, or specifier, the nursery stock may be designated in marketing materials or in specification documents as being transplanted or root pruned a certain number of times. In such cases, the grower may ship the nursery stock with a root ball size smaller than shown in Table 20. **This approach is intended to assist those members of the trade who recognize the value of enhanced cultural practices in the nursery industry.**

Table 20 – Ball sizes – Coniferous evergreens

Note: Plant sizes and caliper measurements indicate minimum size in the size interval (e.g., “4½ in.” caliper indicates 4½ -5 in. caliper interval).

Types 1, 2, and 3 Spreading, semi-spreading, broad spreading, globe, and compact upright		Types 4 and 5 Pyramidal, broad upright		Type 6* Columnar	
Spread (Types 1 and 2) Height (Type 3)	Minimum diameter ball	Height/caliper	Minimum diameter Ball	Height/caliper	Minimum diameter ball
9 in.	8 in.	12 in.	8 in.	12 in.	7 in.
12 in.	10 in.	15 in.	10 in.	15 in.	8 in.
15 in.	12 in.	18 in.	12 in.	18 in.	9 in.
18 in.	14 in.	24 in.	14 in.	24 in.	11 in.
24 in.	16 in.	30 in.	16 in.	30 in.	13 in.
30 in.	18 in.	3 ft.	18 in.	3 ft.	14 in.
36 in.	24 in.	4 ft.	20 in.	4 ft.	16 in.
42 in.	26 in.	5 ft.	22 in.	5 ft.	18 in.
4 ft.	28 in.	6 ft.	24 in.	6 ft.	20 in.
5 ft.	36 in.	7 ft.	26 in.	7 ft.	22 in.
6 ft.	40 in.	8 ft.	28 in.	8 ft.	24 in.
7 ft.	46 in.	9 ft./3 in.	32 in.	9 ft./2 ½ in.	26 in.
8 ft.	52 in.	3 ½ in.	34 in.	3 in.	28 in.
		4 in.	38 in.	3 ½ in.	32 in.
		4 ½ in.	42 in.	4 in.	36 in.
		5 in.	48 in.	4 ½ in.	40 in.
		5 ½ in.	54 in.	5 in.	44 in.
		6 in.	60 in.	5 ½ in.	48 in.
		7 in.	72 in.	6 in.	54 in.
		8 in.	84 in.	7 in.	66 in.
		9 in.	90 in.	8 in.	78 in.
				9 in.	90 in.

*Note: rapid growing varieties may have root balls one size smaller.

3.3.1.1 Natural and semi-sheared

Table 20 should be used to determine the minimum root ball size for natural and semi-sheared coniferous evergreens. If caliper measurement of the plant is shown in this table, **caliper shall take precedence** in determining minimum root ball size, regardless of the height of the plant (e.g., Type 4 plant, 5' ht., 3½" caliper, will require 34" diameter root ball).

3.3.1.2 Sheared

See Section 3.1.3 and appropriate references to Section 1 root ball diameter guidelines.

3.3.1.3 Dwarf varieties

Minimum root ball diameters for dwarf varieties should be equal to those shown in Table 20 for the next larger size non-dwarf varieties.

3.3.2 Trunk in center of ball

Plants dug to the specifications in Table 20 should have the trunk or stem of the plant in the center of the earth ball. A tolerance of 10% of the diameter is the maximum deviation allowable.

Example: For an evergreen with a 30-inch root ball, the center of the plant at ground level shall be within a circle 13½ inches from the outer edge of the ball.

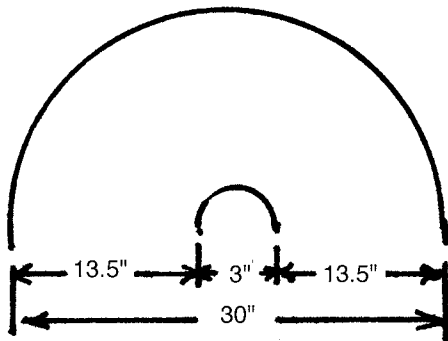

FIGURE 21 – Example: trunk in center of earth ball

3.3.3 Ball depths

Measurement: Depth of the ball is measured from the top of the ball, which in all cases shall begin at the root flare. Soil above the root flare, from being deeply planted in the nursery as a young plant, as a result of maintenance practices in the nursery, or added during harvest, shall not be included in ball depth measurement.

Under certain soil and regional conditions, plants have root systems of proportionately less depth and greater diameter. These require a more shallow but wider ball to properly encompass the roots. Conversely, in other soils and in certain regions roots develop greater depth and less spread, requiring an exceptionally deep ball, unless it has been demonstrated to the purchaser or his representative that the plants have been root pruned or undercut.

For the greater part of the country, ball depths will carry the following ratios:

Balls with diameters less than 20 inches — depth not less than 65% of the diameter of the ball.

Balls with diameters of 20 inches or more — depth not less than 60% of the diameter of the ball.

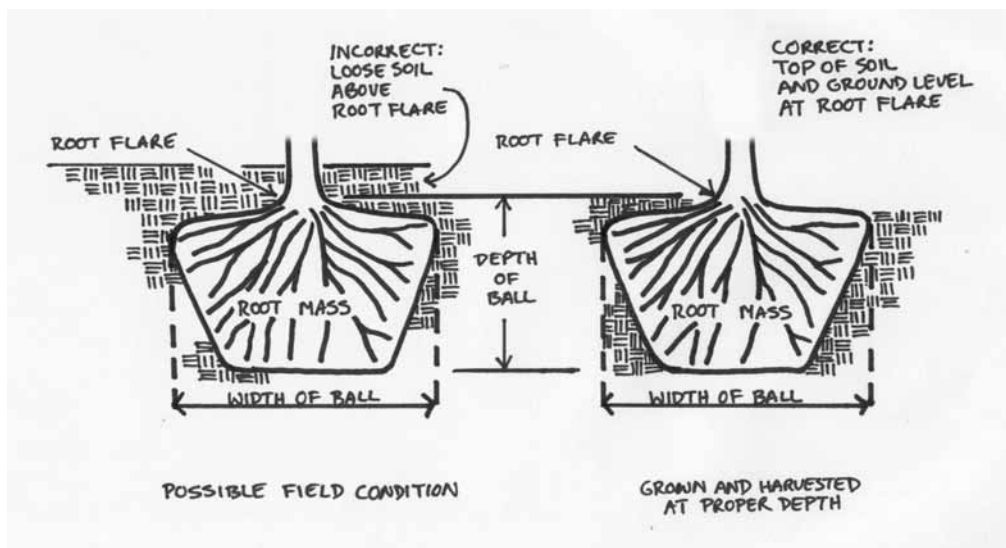

FIGURE 22 – Ball Depths – coniferous evergreens

3.3.4 Burlapping

Burlap or other suitable material shall be biodegradable and shall completely cover the root ball. This wrapping shall be between the earth ball and the lacing or ball supporting device.

3.3.5 Ball supporting devices

If used, ball supporting devices, such as wire baskets, shall hold the ball in a firm, rigid condition.

3.3.6 Collected

Definition: Plants collected from unmanaged land.

Collected (Coll.) plants shall be so designated. It is generally recognized that plants

growing in their native state will sustain a much more severe shock when transplanted than the same kinds of plants when nursery grown.

If collected material is moved, a considerably larger ball than that recommended for transplanted nursery stock is required, because of the unrestricted root development and the varying conditions of soil in which such material is found.

The minimum ball size shall be equal to those specified in Table 20 for the next larger size nursery field grown stock.

For the purposes of this standard, plants collected from wild or native stands may be considered nursery grown when they have been successfully reestablished in the nursery row and grown under regular nursery cultural practices for a minimum of two growing seasons and have attained adequate root and top growth to indicate full recovery from transplanting into the nursery row.

3.3.7 Plantation grown

Definition: Plants which have been systematically planted in fertile, friable soil that is relatively free of stones and foreign matter, but where plants have had a minimum of after-care.

Plantation grown nursery stock shall be so designated. The minimum ball size shall be equal to that specified in Table 20 for the next larger size nursery field grown stock.

3.3.8 Field potted

Balled and potted plants are nursery field grown plants, dug with a ball of earth still intact in which they are growing, and which, in lieu of burlapping, are placed in a container to retain the ball unbroken.

The minimum ball size shall be equal to that specified in Table 20.

3.3.9 Use of digging machines

It is recognized that balling of nursery grown stock can be accomplished by hand digging or by mechanical devices especially designed for nursery conditions. The use of digging machines is an acceptable nursery practice.

3.4 Container grown specifications

All specifications for container grown plants shall include **both plant size and container size**. Plant size intervals and reference to height or spread shall be in accordance with the guidelines for the appropriate plant type set forth in Section 3.2 Types of Conifers. Container size shall be by container classification (i.e., not by container volume) as set forth in the container class table in the Foreword.

In all cases, container grown nursery stock shall meet the following general requirement:

All container grown nursery stock shall be healthy, vigorous, well rooted, and established in the container in which it is growing. Container grown nursery stock shall have a well-established root system reaching the sides of the container to maintain a firm ball when the container is removed, but shall not have excessive root growth encircling the inside of the container.

It is recognized that certain containers may be designed or treated to retard circling roots around the inside of the container, and that they are acceptable in the trade.

The container shall be sufficiently rigid to hold the ball shape and to protect the root mass during shipping.

Table 21 – Container class guidelines – Natural, Semi-sheared, or Lightly Sheared Evergreens

All specifications shall include plant size designation. The container class is a secondary specification that should be determined after the desired plant size is determined. This table should not be used as the basis for rejecting nursery stock based on the minimum or maximum plant size shown in this table in cases where a specification only provides a container class designation. In such cases, the parties should refer to the “general requirement” for all container grown nursery stock (see Section 3.4) to determine whether the root system complies with the Standard.

Sheared Form not covered by this section: See Section 3.1.3 and appropriate references to Section 1 Container Class Guidelines.

How to use this table: (1) Identify the appropriate column according to plant type. (2) Identify every row with a plant size range that includes the desired plant size. (3) Specify an appropriate container class in the right-hand column of a row in which the desired plant size falls *between the minimum and maximum* plant size shown. For example, a 30” sp. Type 2 plant is included as the maximum plant size for a #5 container and would NOT be appropriate. A 30” sp. Type 2 plant is included as the minimum plant size for a #15 container and would NOT be appropriate. The appropriate container class would be either a #7 or #10, since the 30” sp. plant size falls between the minimum and maximum plant sizes in those ranges.

Dwarf varieties: Specifiers are encouraged to designate a container class that is *at least one container class larger* than shown in this table for the minimum plant size shown. For example, a “#3” container class designation might be appropriate for a “6 in.” plant size designation for a dwarf plant.

Fast-growing varieties: Specifiers may designate a container class that is one container class smaller than shown in this table for the maximum plant size shown. For example, a “#15” container class designation might be appropriate for a “10 ft.” plant size designation for an exceptionally fast-growing plant (e.g., Cupressocyparis Leylandi)

Note: Throughout this Standard, plant size indicates minimum allowable plant size in plant size range (e.g., “12 in. sp.” specification designates size range from 12-inch spread up to but not including 15-inch spread).

Types 1, 2, and 3 Measurement designates spread (Types 1 and 2) or height (Type 3)		Types 4, 5, and 6 Measurement designates height		
Min. Plant Size	Max. Plant Size	Min. Plant Size	Max. Plant Size	Container Class*
6 in.	12 in.	6 in.	15 in.	1
9 in.	15 in.	12 in.	24 in.	2
12 in.	24 in.	15 in.	3 ft.	3
15 in.	30 in.	18 in.	4 ft.	5
18 in.	4 ft.	24 in.	6 ft.	7
24 in.	5 ft.	30 in.	7 ft.	10
30 in.	6 ft.	4 ft.	8 ft.	15
36 in.	8 ft.	5 ft.	10 ft.	25
42 in.	8 ft.	6 ft.	12 ft.	45
4 ft.	10 ft.	7 ft.	16 ft.	65
5 ft.	12 ft.	8 ft.	20 ft.	100

*See Container Classification Table in the Foreword.

3.5 In-ground fabric bag-grown

These specifications are for natural, semi-sheared, or lightly-sheared coniferous evergreens field grown in fabric bags, commonly called grow bags. Sheared nursery stock should reference one size larger than shown in the table. Fabric bag size specifications are provided in the Foreword.

The following table represents the recommended maximum height for coniferous evergreens grown in in-ground fabric bags. Coniferous evergreens are classified into two categories — faster growing conifers that attain height more quickly in relation to caliper; and slower growing varieties that attain caliper more quickly in relation to height.

Examples of rapid growing varieties include *Pinus strobus*, *Pinus taeda*, *Cupressocyparis leylandii*, *Juniperus scopulorum*, *Juniperus virginiana*, and *Thuja orientalis*. Examples of slower growing varieties include *Pinus nigra*, *Pinus sylvestris*, *Pinus resinosa*, *Pinus cembra*, *Pinus thunbergii*, and *Picea pungens*.

Table 22—Fabric bag sizes—Coniferous evergreens

Faster Growing		Slower Growing	
Maximum height	Minimum recommended fabric bag size	Maximum height	Minimum recommended fabric bag size
4 ft.	10 in.	3 ft.	10 in.
5 ft.	12 in.	4 ft.	12 in.
6 ft.	14 in.	5 ft.	14 in.
8 ft.	16 in.	6 ft.	16 in.
10 ft.	18 in.	7 ft.	18 in.
12 ft.	20 in.	8 ft.	20 in.
14 ft.	22 in.	10 ft.	22 in.
16 ft.	24 in.	12 ft.	24 in.

Section 4: Broadleaf Evergreens

This section applies to plants generally sold to the retail and landscape trade. For liner grades see Section 6.

4.1 Specifications - general

4.1.1 – Required specifications

For **field grown** stock (Section 4.3), specifications shall include plant size, by spread or height, as appropriate to the plant type, and shearing designation.

For **container** grown stock (Section 4.4), specifications shall include plant size, by spread or height, as appropriate to the plant type, shearing designation, and container class.

For **fabric bag** grown stock (Section 4.5), specifications shall include plant size, by spread or height, as appropriate to the plant type, shearing designation, and minimum fabric bag size.

If a specification does not include a shearing designation, nursery stock fitting the definition of any shearing designation, except altered form, shall be deemed as acceptable within the terms of this section (See Section 4.1.2).

4.1.1.1 Plant size intervals

General practice is for a **plant size specification** to express only the minimum for the desired size interval. Each interval includes plants from the minimum plant size up to but not including the next larger size interval. Acceptable size intervals for each plant type are shown in the appropriate plant type sections, below. For instance, a specification for a “12 in.” Type 2 plant references the “12 to 15 inch” spread interval, while a specification for an “18 in.” Type 3 plant references the “18 to 24 inch” height interval (see Section 4.2).

4.1.1.2 Spread and height measurements

Spread measurements shall not be taken at the tips of the outermost branches of the plant, but should be an average (see Figures 23 and 24). Height measurement shall not be taken at the tips of the uppermost branches of the plant, but should be an average (see Figures 25, 26, and 27).

4.1.2 Shearing designations

Natural – plant grown with only corrective or reparative pruning, leaving the form that is natural for the species. Never sheared. Specify as “N” (e.g., *Ilex crenata* ‘convexa,’ N, 24”, B&B or #7).

Semi sheared or lightly sheared – symmetrically sheared, pruned, or disbudded when the plant is young and then only periodically thereafter during the life of the plant. The intent is to retain an intermediate level of density while retaining the form that is natural for the species and not limiting the height of the plant over a period of time. Trunk caliper shall not be significantly larger than the trunk caliper of a plant that has been allowed to grow as a natural form, defined above. Specify as “LS.”

Sheared – annually or semi-annually sheared, pruned, or disbudded to retain a symmetrical shape, make the plant very dense, and limit the height and width of the plant over a period of time. The trunk caliper of the plant will therefore continue to increase at a disproportionate rate to the plant size, and will be larger than the trunk caliper of a plant that has been allowed to grow naturally. Specify as “S.”

Altered form – sheared or pruned to attain a shape or branching habit that is not natural for the species, such as topiary, espalier, trained with wire, etc. Specifications should include minimum root ball size or container class.

4.1.3 – Determining root ball, container, or fabric bag size

For **natural or semi-sheared** broadleaf evergreens, root ball size shall be determined in accordance with Table 26, and container size shall be determined in accordance with Table 27, below.

For **sheared** broadleaf evergreens, the following language shall apply:

Where it has been a cultural practice to shear, prune, disbud or otherwise impede the natural growth rate of this group of plants, other than by root pruning, caliper measurement shall be used to determine the minimum ball size.

Measurement of trunk diameter of sheared broadleaf evergreens shall be made in the manner set forth for Shade and Flowering Trees (see Section 1.1.1.2). In those cases where branches interfere with caliper measurement, caliper shall be taken just above, and as near to, the six inch or 12 inch location on the trunk as practicable.

Minimum ball diameters, container class, and fabric bag size for sheared broadleaf evergreens shall be those established in Section 1 for Types 1 and 2 Shade Trees (see appropriate Table 6, Table 8, or Table 9), with caliper taking precedence over height in all cases where caliper is shown. Ball depths for sheared plants shall also be established as in Section 1.6.1.

4.1.4 Optional specifications and quality designations

Nursery stock shipped in accordance with the required specifications shall be deemed to be acceptable within the terms of this section if it is typical in size and habit for the species in the region of the country in which it is grown unless specifications include additional details. Specifiers and buyers are encouraged to provide additional appropriately detailed descriptive language to the extent that required specifications set forth in Section 4.1.1 do not provide sufficient detail for a particular transaction.

4.1.4.1 Height and spread

If only height or spread shall be specified, both height and spread may be specified.

4.1.4.2 Transplanting or root pruning

In certain landscapes, such as container plantings with limited soil availability, or when the buyer desires a particularly well-formed root mass, specifications should include the minimum number of times that nursery stock must have been root pruned or transplanted (e.g., “trans. 3x”). In such cases, nursery stock may be shipped with a root ball smaller than that shown in Table 26, and the smaller root ball may be specified. Root ball sizes in Table 26 are based on trees that have not been transplanted after they have been lined out in the field, which is the typical and accepted practice in the industry.

4.1.4.3 Specimen or quality grade designation, collected stock

General terms, such as “specimen,” or “quality grade,” should be avoided in favor of more specific terms that describe the plant attributes required by the specifier or buyer, such as “symmetrical,” “extra heavy branching,” “matching,” or “single leader.” The determination of compliance with the term “specimen” shall be determined with reference to the descriptive characteristics provided in the specifications by the buyer or specifier.

Collected stock (Coll.), natural seedling plants dug from native stands or forest plantings, shall be so designated (see Section 4.3.6).

4.1.4.4 Minimum or maximum caliper

In addition to the required height designation, specifications may include minimum or maximum calipers to limit root ball size, and sellers may include minimum or maximum calipers within size intervals in inventory and marketing materials.

4.1.5 Dwarf broadleaf evergreens

Dwarf varieties are not treated as a separate plant type for purposes of this section. They should be specified within the appropriate plant types shown in Section 4.2, below, in accordance with the natural habit of the particular cultivar.

4.2 Types of broadleaf evergreens

4.2.1 Type 1—Spreading type

Definition: Plants that generally do not exceed three feet in height at maturity, with spread increasing over time with little or no increase in height. Tall plants with a weeping habit should not be included in this plant type.

Examples: *Calluna vulgaris* (and cultivars), *Carissa grandiflora* 'Green Carpet,' *Cotoneaster dammeri*, *C. horizontalis* (and cultivars), *Cytisus* 'Lydia,' *Ilex crenata* 'Helleri,' *Mahonia nervosa*, *M. repens*

Measurement: Measurement indicates spread (height not considered), using three-inch intervals through 15-18", then six-inch intervals through 42-48", then one-foot intervals from 4-5' and up.

Measurement should be the average of the plant and not the greatest diameter. Plants properly trimmed and transplanted should measure the same in any direction. If a plant is uneven, for example, 15 inches the widest and nine inches the narrowest, it should be classified as 12-in. stock.

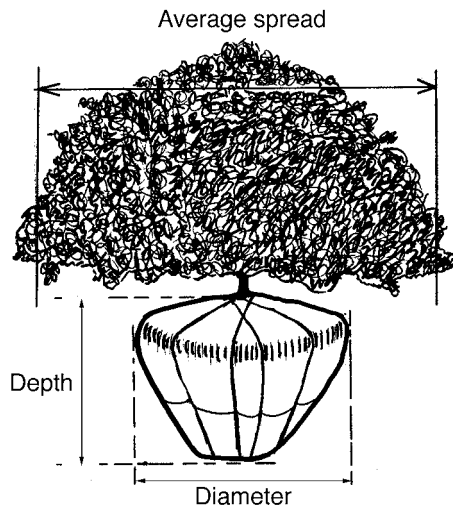

FIGURE 23 – Measurement – Type 1 Broadleaf evergreens

4.2.2 Type 2—Semi-spreading type

Definition: Height will be less than spread. Height will be at least one-half the spread up to 30-36" spread; the height will remain less than the spread thereafter, varying somewhat according to natural growth of the particular species and method of handling.

Examples: *Berberis verruculosa*, *Cotoneaster franchetii*, *C. salicifolia*, *Daphne odora*, *Ilex crenata* 'Convexa,' *I. Crenata* 'Hetzi,' *Leucothoe axillaris*, *L. fontanesiana*, *Pieris floribunda*, *Raphiolepis umbellata*, *Rhododendron* (*Azalea*) *obtusum* 'Amoenum,' *R. Gumpo* and *Kurume* hybrid types, *R. impenitum*

Measurement: Measurement indicates spread (height not considered), using three-inch intervals through 15-18", then six-inch intervals through 42-48", then one-foot intervals from 4-5' and up.

Measurement should be the average of the plant and not the greatest diameter. Plants properly trimmed and transplanted should measure the same in any direction. If a plant is uneven, for example, 15 inches the widest and nine inches the narrowest, it should be classified as 12-in. stock.

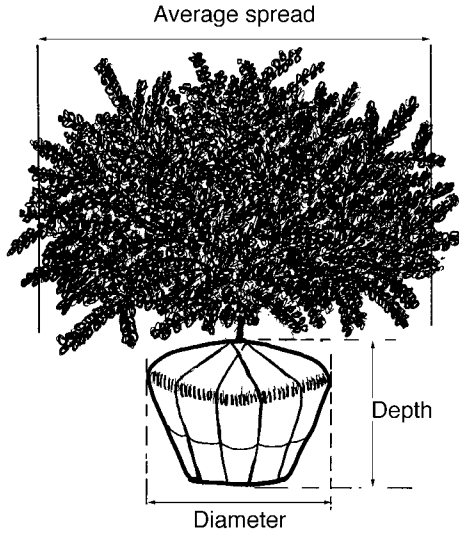

FIGURE 24 – Measurement – Type 2 Broadleaf evergreens

4.2.3 Type 3—Broad spreading, globe, or compact upright type

Definition: Spread will usually be equal to or only slightly less than the height, up to 12 inches. From there on, the spread may be less than the height, but in no case will the ratio of height to spread be more than 2:1 (height more than twice the spread). Both dimensions may be given, as a good practice.

Table 23—Type 3 broadleaf evergreens

Height	Minimum spread
6 in.	5 in.
9 in.	6 in.
12 in.	7 in.
15 in.	9 in.
18 in.	10 in.
24 in.	14 in.

Examples: *Buxus microphylla* (dwarf cultivars), *B. sempervirens* 'Suffruticosa,' *Ilex cornuta* 'Rotunda,' *I. vomitoria* 'Nora,' *Leiophyllum buxifolium*

Measurement: Measurement indicates height (spread not considered), using three-inch intervals through 15-18”, then six-inch intervals through 42-48”, then one-foot intervals from 4-5’ and up.

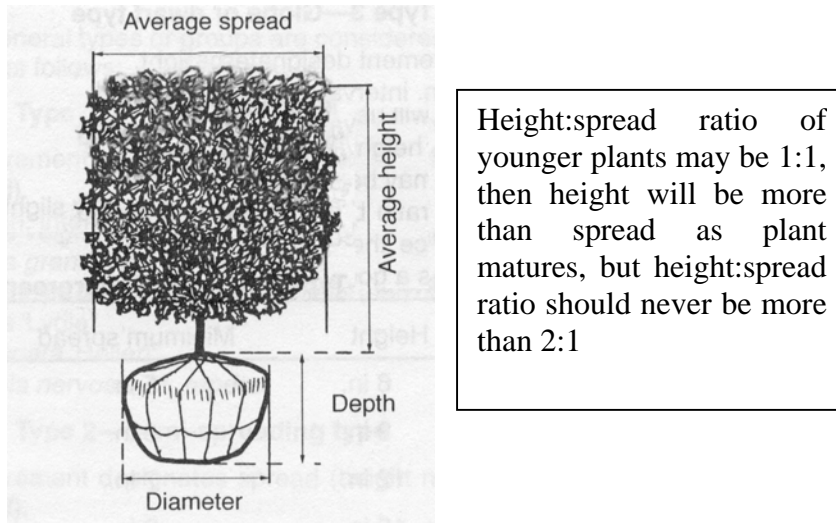

FIGURE 25 – Measurement – Type 3 Broadleaf evergreens

4.2.4 Type 4—Broad upright type

Definition: This group includes all of the larger growing upright “broadleaves” which vary considerably in ratio of spread to height. Well-grown material in most cases will have a height equal to if not greater than the spread. However, the spread should not be less than two-thirds of the height (height-to-spread ratio of 3:2).

Table 24—Type 4 and 5 broadleaf evergreens

Height	Minimum spread
12 in.	8 in.
15 in.	10 in.
18 in.	12 in.
24 in.	16 in.
30 in.	20 in.
3 ft.	24 in.
4 ft.	28 in.

Examples: *Abelia grandiflora*, *Aucuba japonica* (and cultivars), *Azalea* ‘Rosebud,’ *Berberis julianae*, *Cytisus* ‘Burkwoodii,’ *Elaeagnus pungens*, *Gardenia jasminoides*, *Ilex cornuta* (and cultivars), *I. crenata* ‘Rotundifolia,’ *Kalmia latifolia*, *Ligustrum lucidum*, *L. japonicum* (shrub forms), *Mahonia aquifolium*, *Pieris japonica*, *Rhododendron* (cultivars), *Viburnum rhytidophyllum*

Measurement: Measurement designates height, using three-inch intervals through 15-18”, then six-inch intervals from through 30-36”, then one-foot intervals from 3-4’ and up.

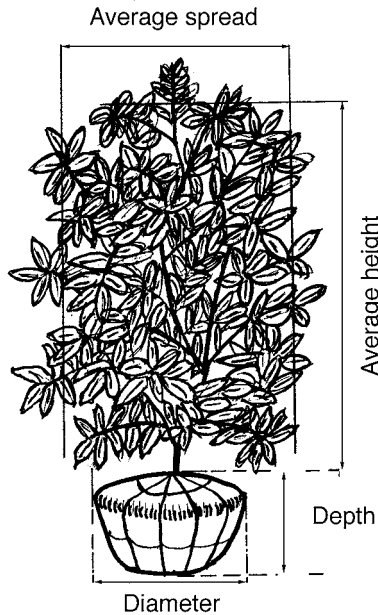

FIGURE 26 – Measurement – Type 4 Broadleaf evergreens

4.2.5 Type 5—Cone type

Definition: This type includes all upright growing broadleaf evergreens which naturally develop into a conical form. Similar to Type 4 plants, well grown material will have a height to spread ratio of 3 to 2. However, a greater spread is acceptable.

Examples: *Camellia japonica*, *C. sasanqua*, *Ilex aquifolium*, *I. opaca* (and cultivars), *Ilex attenuata* ‘Foster No. 2,’ *I. ‘Nellie R. Stevens,’* *Illicium anisatum*, *Prunus caroliniana*, *P. laurocerasus*, *P. lusitanica*

Measurement: Measurement designates height, using three-inch intervals through 15-18”, then six-inch intervals from through 30-36”, then one-foot intervals from 3-4’ and up.

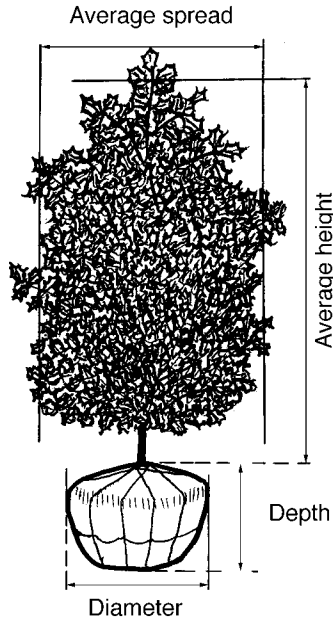

FIGURE 27 – Measurement – Type 5 Broadleaf evergreens

4.2.6 Type 6 - Columnar type

Definition: This group includes the upright growing evergreens which naturally develop a straight sided form or one that tapers only slightly from the ground to a point more than half the height.

The broader types will usually have a ratio of height to spread of 4 to 1. Many forms, however, will not attain this ratio, and even those of broad habit may be trimmed to advantage into a narrowed form. However, in most cases the ratio of height to spread should be less than 5 to 1.

Examples: *Ilex crenata* ‘Sky Pencil,’ *Buxus* ‘Graham Blandy,’ *Buxus* ‘DeeRunk,’ *Buxus fastigiata*

Measurement: Measurement indicates height, using three-inch intervals through 15-18”, then six-inch intervals through 30-36”, then one-foot intervals through 9-10’, then two-foot intervals from 10-12’ and up.

Table 25–Type 6 Broadleaf evergreens

Height	Maximum spread
12 in.	3 to 6 in.
15 in.	4 to 7 in.
18 in.	5 to 8 in.
24 in.	6 to 9 in.

30 in.	7 to 10 in.
3 ft.	9 to 12 in.
4 ft.	12 to 15 in.
5 ft.	15 to 18 in.
6 ft.	18 to 21 in.
7 ft.	21 to 24 in.
8 ft.	24 to 30 in.

4.3 Root ball guidelines

4.3.1 Root ball diameters - field grown broadleaf evergreens

The following tables represent the recommended minimum root ball sizes for broadleaf evergreens which are being grown in the ground in the nursery without artificial root restriction devices, such as containers or fabric bags, under favorable growing conditions and which have received the proper cultural treatment to develop a well branched root system. These specifications are for plants harvested with the ball of earth in which they are growing remaining intact.

Many factors affect the minimum root ball size. Although minimum ball size is not a required specification, parties to nursery stock transactions are encouraged to address minimum ball size in personal communications or specification documents prior to the transaction. The objective in all nursery stock transactions is for root balls to meet the following general requirement:

Ball sizes should always be of a diameter and depth to encompass enough of the fibrous and feeding root system as necessary for the full recovery of the plant.

Given the variety of acceptable cultural practices in the industry, the ball sizes set forth in this section are based on those factors which are objectively observable and measurable: the spread or height of the plant, and the caliper of the trunk in cases where the size of the plant has been controlled through shearing techniques. Other cultural practices in the nursery, such as transplanting or root pruning practices or watering techniques, or soil types and local growing conditions, certainly affect the density of the roots, but are much more difficult to observe and measure within the context of the Standard.

It is recognized that plants having a coarse or wide-spreading root system because of natural habit of growth, soil condition, infrequent transplanting practice, or plants that are moved out of season, would require a root ball larger than the recommended size. It is also recognized that there may be circumstances where the sizes recommended may be excessive, such as stock grown in pots or other containers, field plants recently planted out from containers or with smaller balls, or plants which have been frequently transplanted or root pruned.

For example, if root density is of particular importance to a seller, buyer, or specifier, the nursery stock may be designated in marketing materials or in specification documents as being transplanted or root pruned a certain number of times. In such cases, the grower may ship the nursery stock with a root ball size smaller than shown in Table 26. **This approach is intended to assist those members of the trade who recognize the value of enhanced cultural practices in the nursery industry.**

Table 26 – Ball sizes – Broadleaf evergreens

Note: Plant sizes and caliper measurements indicate minimum size in the size interval (e.g., “4½ in.” caliper indicates 4½ -5 in. caliper interval).

Types 1, 2, and 3 Spreading, semi-spreading, broad spreading, compact upright, and globe		Types 4 and 5 Broad upright, Cone		Type 6 Columnar	
Spread (Types 1 and 2) or Height (Type 3)	Minimum diameter ball	Height/caliper	Minimum diameter Ball	Height/caliper	Minimum diameter ball
9 in.	8 in.	12 in.	8 in.	12 in.	7 in.
12 in.	10 in.	15 in.	10 in.	15 in.	8 in.
15 in.	12 in.	18 in.	12 in.	18 in.	9 in.
18 in.	14 in.	24 in.	14 in.	24 in.	11 in.
24 in.	16 in.	30 in.	16 in.	30 in.	13 in.
30 in.	18 in.	3 ft.	18 in.	3 ft.	14 in.
36 in.	24 in.	4 ft.	20 in.	4 ft.	16 in.
42 in.	26 in.	5 ft.	22 in.	5 ft.	18 in.
4 ft.	28 in.	6 ft.	24 in.	6 ft.	20 in.
5 ft.	36 in.	7 ft.	26 in.	7 ft.	22 in.
6 ft.	40 in.	8 ft.	28 in.	8 ft.	24 in.
7 ft.	46 in.	9 ft./3 in.	32 in.	9 ft./2 ½ in.	26 in.
8 ft.	52 in.	3 ½ in.	34 in.	3 in.	28 in.
		4 in.	38 in.	3 ½ in.	32 in.
		4 ½ in.	42 in.	4 in.	36 in.
		5 in.	48 in.	4 ½ in.	40 in.
		5 ½ in.	54 in.	5 in.	44 in.
		6 in.	60 in.	5 ½ in.	48 in.
		7 in.	72 in.	6 in.	54 in.
		8 in.	84 in.	7 in.	66 in.
		9 in.	90 in.	8 in.	78 in.
				9 in.	90 in.

4.3.1.1 Natural and semi-sheared

This table should be used to determine the minimum root ball size for natural and semi-sheared coniferous evergreens. If caliper measurement of the plant is shown in this table, **caliper shall take precedence** in determining minimum root ball size, regardless of the height of the plant (e.g., Type 4 plant, 5' ht., 3½" caliper, will require 34" diameter root ball).

4.3.1.2 Sheared

See Section 4.1.3 and appropriate references to Section 1 root ball diameter guidelines.

4.3.1.3 Dwarf varieties

Minimum size root balls for dwarf varieties should be equal to those shown for the next larger size non-dwarf varieties.

4.3.2 Trunk in center of ball

Plants dug to the specifications in the following tables should have the trunk or stem of the plant in the center of the earth ball. A tolerance of 10% of the diameter is the maximum deviation allowable.

Example: For an evergreen with a 30-inch root ball, the center of the plant at ground level shall be within a circle 13½ inches from the outer edge of the ball.

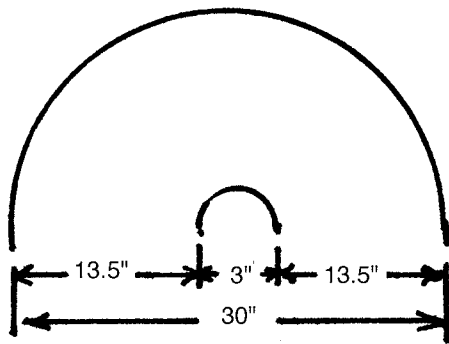

FIGURE 28 – Example: trunk in center of earth ball

4.3.3 Ball depths

Measurement: Depth of the ball is measured from the top of the ball, which in all cases shall begin at the root flare. Soil above the root flare, from being deeply planted in the nursery as a young plant, as a result of maintenance practices in the nursery, or added during harvest, shall not be included in ball depth measurement.

Under certain soil and regional conditions, plants have root systems of proportionately less depth and greater diameter. These require a more shallow but wider ball to properly encompass the roots.

Conversely, in other soils and in certain regions roots develop greater depth and less spread, requiring an exceptionally deep ball, unless it has been demonstrated to the purchaser or his representative that the plants have been root pruned or undercut.

For the greater part of the country, ball depths will carry the following ratios:

Balls with diameters less than 20 inches — depth not less than 65% of the diameter of the ball.

Balls with diameters of 20 inches or more — depth not less than 60% of the diameter of the ball.

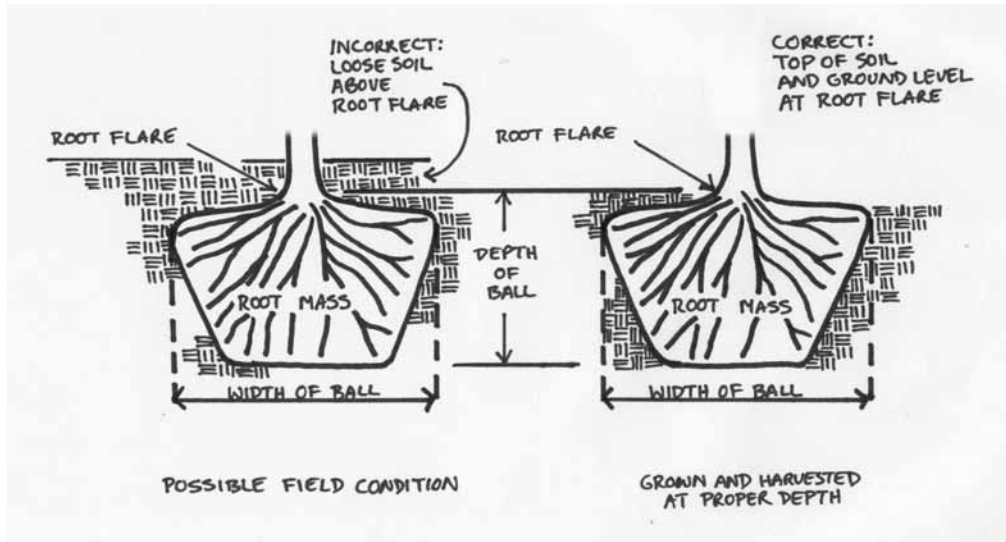

FIGURE 29 – Ball Depth Measurement – REVISED GRAPHIC

4.3.4 Burlapping

Burlap or other suitable material shall be biodegradable and shall completely cover the root ball. This wrapping shall be between the earth ball and the lacing or ball supporting device.

4.3.5 Ball supporting devices

If used, ball supporting devices, such as wire baskets, shall hold the ball in a firm, rigid condition.

4.3.6 Collected

Definition: Plants collected from unmanaged land.

Collected (Coll.) plants shall be so designated. It is generally recognized that plants growing in their native state will sustain a much more severe shock when transplanted than the same kinds of plants when nursery grown.

If collected material is moved, a considerably larger ball than that recommended for transplanted nursery stock is required, because of the unrestricted root development and the varying conditions of soil in which such material is found.

The minimum ball size shall be equal to those specified in Table 26 for the next larger size nursery field grown stock.

For the purposes of this standard, plants collected from wild or native stands may be considered nursery grown when they have been successfully reestablished in the nursery row and grown under regular nursery cultural practices for a minimum of two growing seasons and have attained adequate root and top growth to indicate full recovery from transplanting into the nursery row.

4.3.7 Plantation grown

Definition: Plants which have been systematically planted in fertile, friable soil that is relatively free of stones and foreign matter, but where plants have had a minimum of after-care.

Plantation grown nursery stock shall be so designated. The minimum ball size shall be equal to that specified in Table 26 for the next larger size nursery field grown stock.

4.3.8 Field potted

Balled and potted plants are nursery field grown plants, dug with a ball of earth still intact in which they are growing, and which, in lieu of burlapping, are placed in a container to retain the ball unbroken.

The minimum ball size shall be equal to that specified in Table 26.

4.3.9 Use of digging machines

It is recognized that balling of nursery grown stock can be accomplished by hand digging or by mechanical devices especially designed for nursery conditions. The use of digging machines is an acceptable nursery practice.

4.4 Container grown specifications

All specifications for container grown plants shall include **both plant size and container size**. Plant size intervals and reference to height or spread shall be in accordance with the guidelines for the appropriate plant type set forth in Section 4.2 Types of Broadleaf evergreens. Container size shall be by container classification (i.e., not by container volume) as set forth in the container class table in the Foreword.

In all cases, container grown nursery stock shall meet the following general requirement:

All container grown nursery stock shall be healthy, vigorous, well rooted, and established in the container in which it is growing. Container grown nursery stock shall have a well-established root system reaching the sides of the container to maintain a firm ball when the container is removed, but shall not have excessive root growth encircling the inside of the container.

It is recognized that certain containers may be designed or treated to retard circling roots around the inside of the container, and that they are acceptable in the trade.

The container shall be sufficiently rigid to hold the ball shape and to protect the root mass during shipping.

Table 27 – Container Class Guidelines – Natural, Semi, or Lightly Sheared Evergreens

All specifications shall include plant size designation. The container class is a secondary specification that should be determined after the desired plant size is determined. This table should not be used as the basis for rejecting nursery stock based on the minimum or maximum plant size shown in this table in cases where a specification only provides a container class designation. In such cases, the parties should refer to the “general requirement” for all container grown nursery stock (see Section 4.4) to determine whether the root system complies with the Standard.

Sheared form not covered by this section: See Section 4.1.3 and appropriate references to Section 1 Container Class Guidelines.

How to use this table: (1) Identify the appropriate column according to plant type. (2) Identify every row with a plant size range that includes the desired plant size. (3) Specify an appropriate container class in the right-hand column of a row in which the desired plant size falls between the minimum and maximum plant size shown. For example, a 30” sp. Type 2 plant is included as the maximum plant size for a #5 container and would NOT be appropriate. A 30” sp. Type 2 plant is included as the minimum plant size for a #15 container and would NOT be appropriate. The appropriate container class would be either a #7 or #10, since the 30” sp. plant size falls between the minimum and maximum plant sizes in those ranges.

Dwarf varieties: Specifiers are encouraged to designate a container class that is at least one container class larger than shown in this table for the minimum plant size shown. For example, a “#3” container class designation might be appropriate for a “6 in.” plant size designation for a dwarf plant.

Note: Throughout this Standard, plant size indicates minimum allowable plant size in plant size range (e.g., “12 in. sp.” specification designates size range from 12-inch spread up to but not including 15-inch spread).

Types 1 and 2 Measurement designates spread		Types 3, 4, 5, and 6 Measurement designates height		Container class*
Min. plant size	Max. plant size	Min. plant size	Max. plant size	
6 in.	12 in.	6 in.	15 in.	1
9 in.	15 in.	12 in.	24 in.	2
12 in.	24 in.	15 in.	3 ft.	3
15 in.	30 in.	18 in.	4 ft.	5
18 in.	4 ft.	24 in.	6 ft.	7
24 in.	5 ft.	30 in.	7 ft.	10
30 in.	6 ft.	4 ft.	8 ft.	15
36 in.	8 ft.	5 ft.	10 ft.	25
42 in.	8 ft.	6 ft.	12 ft.	45
4 ft.	10 ft.	7 ft.	16 ft.	65
5 ft.	12 ft.	8 ft.	20 ft.	100

*See Container Classification Table in the Foreword.

4.5 In-ground fabric bag-grown

These specifications are for natural, semi-sheared, or lightly-sheared broadleaf evergreens field grown in fabric bags, commonly called grow bags. Sheared nursery stock should reference one size larger than shown in the table. Fabric bag size specifications are provided in the Foreword.

The following table represents the recommended maximum height for cone-type and broad upright-type broadleaf evergreens grown in in-ground fabric bags.

Table 28—Fabric bag sizes—Types 4 and 5 broadleaf evergreens

Maximum plant height	Minimum recommended fabric bag size
3 ft.	10 in.
4 ft.	12 in.
5 ft.	14 in.
6 ft.	16 in.
8 ft.	18 in.
9 ft.	20 in.
10 ft.	22 in.
12 ft.	24 in.

Section 5:

Rose Grades

5.1 General garden rose

The standards specified apply only to field-grown garden roses when sold bare root, or individually wrapped and packaged, or in cartons.

All grades of roses shall have a well-developed root system and have proportionate weight and caliper according to grade and variety. Roses shall be graded by number and caliper of canes.

Rose bushes that do not meet these standards for the individual grades are defined as CULLS.

The grade-sizes for each classification are minimum sizes and not more than 10% of the rose plants in any bundle shall be below the size specified.

As used in the grade-sizes below, “strong cane” means a cane that is healthy, vigorous, and fully developed so that it is hardened-off throughout. The caliper of the cane is measured not higher than 4 inches (10 cm) from the bud union. Finished shipping length not less than 6 inches (15.0 cm).

5.2 Hybrid tea, tea, grandiflora, rugosa hybrids, hybrid perpetuals, moss, and climbing roses

Grade No. 1—At least three strong canes $\frac{5}{16}$ inch (0.8 cm) in caliper and up, branched not higher than 3 inches (8 cm) from the bud union.

Grade No. 1½ —At least two strong canes, $\frac{5}{16}$ inch (0.8 cm) in caliper and up, branched not higher than 3 inches (8 cm) from the bud union.

Grade No. 2—At least two canes, one of which shall be a strong cane, $\frac{5}{16}$ inch (0.8 cm) in caliper and up. The second shall be $\frac{1}{4}$ inch (0.6 cm) in caliper, branched not higher than 3 inches (8 cm) from the bud union.

Note: Although Floribunda roses are included in the above grade standard, it should be noted that Floribunda roses in this group will normally result in the marketing of rose bushes which are, on the average, lighter for this class. Polyantha, Shrub, Landscape, and low growing Floribunda roses may be graded per Section 5.3.

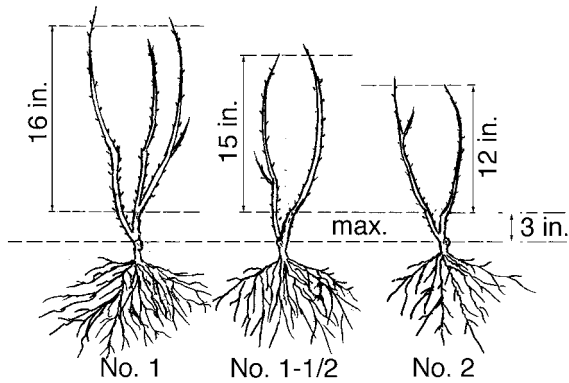

Note: field height shown.

FIGURE 30 – Hybrid tea, tea, grandiflora, etc., roses

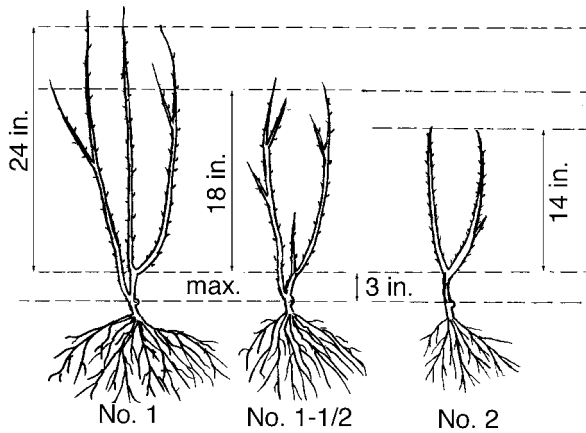

Note: field height shown.

FIGURE 31 – Climbing roses

5.3 Polyantha, shrub, landscape, and low growing floribunda roses

Grade No. 1—At least three (strong) canes $\frac{1}{4}$ inch (0.6 cm) in caliper and up, branched not higher than 3 inches (8 cm) from the bud union.

Grade No. 1 $\frac{1}{2}$ —At least two (strong) canes, $\frac{1}{4}$ inch (0.6 cm) in caliper and up, branched not higher than 3 inches (8 cm) from the bud union.

Grade No. 2—At least two canes, one of which shall be a (strong) cane, $\frac{1}{4}$ inch (0.6 cm) in caliper and up.

Branches more than 3 in. above bud union do not count as canes.

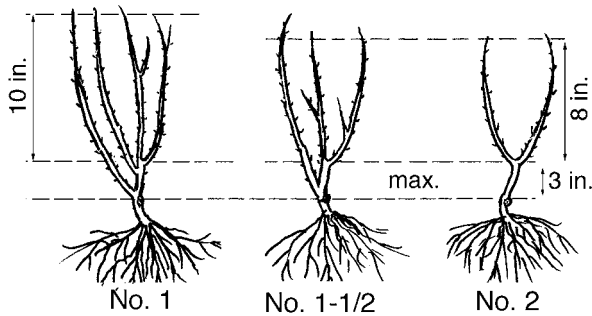

Note: field height shown.

FIGURE 32 – Polyantha roses

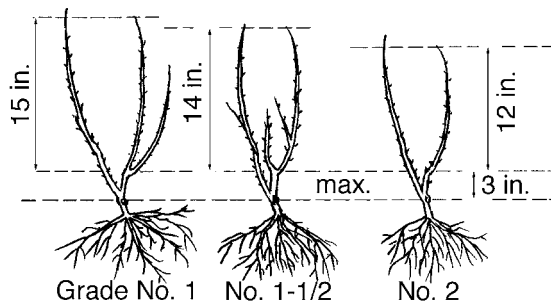

Note: Field height shown. See text for light-growing sorts. Branched not higher than 3 in. above bud union.

FIGURE 33 – Floribunda roses

5.4 Field grown miniatures

(minimum standards)

5.4.1 Large grower

Grade No. 1—At least 2 canes, one of which shall be $\frac{1}{4}$ inch (0.6 cm) in diameter and the other $\frac{9}{32}$ inch (0.7 cm) in diameter or 5 canes, one of which is $\frac{1}{4}$ inch (0.6 cm) in diameter and 4 smaller healthy canes.

Grade No. 2—At least 2 canes, one of which is $\frac{1}{4}$ inch (0.6 cm) in diameter plus 1 healthy cane.

5.4.2 Small grower

Grade No. 1—At least two canes $\frac{9}{32}$ inch (0.7 cm) in diameter or 5 small healthy canes.

Grade No. 2—2 healthy canes.

5.4.3 Root system

Grade No.1—5 inches (13 cm) or more in length, spaced 50% or more around the shank in a balanced fashion.

Grade No. 2—3 to 5 inches (8-13 cm) in length spaced 50% or more around the shank in a balanced fashion.

5.5 Tree roses

5.5.1 Standard tree rose 36" (91 cm)

Grade No. 1—Height 36 inches (91 cm) or more. Standard cane size measured at 3 inches (8 cm) below the bud union, shall be at least $\frac{7}{16}$ inch (11 mm) in diameter. Bud development (head) shall have at least two bud eyes and shall be well branched in a balanced fashion as defined under sections 5.2, 5.3, and 5.4. Standard cane shall be upright and straight.

Grade No. 1½ —Height 36 inches (91 cm) or more. Standard cane size measured at 3 inches (8 cm) below the bud union, shall be at least $\frac{7}{16}$ inch (11 mm) in diameter. Bud development (head) shall have at least two bud eyes and shall be well branched in a balanced fashion as defined under the sections 5.2, 5.3, and 5.4 with 70 % or more head development.

Standard cane shall be upright and straight.

Grade No. 2—Sub standard—All Tree Roses not meeting the No. 1 or No. 1½ grades described above are defined as Sub Standard.

5.5.2 Patio tree rose 18 inches (50 cm)

Grade No. 1—Height at least 18 inches (50 cm) or more not to exceed 36 inches (91 cm). Standard size measured at 3 inches (8 cm) below the bud union, shall be at least $\frac{3}{8}$ inches (10 mm) in diameter. Bud development (head) shall have at least two bud eyes and shall be well branched in a balanced fashion as defined under sections 5.2, 5.3, and 5.4. Standard cane size shall be upright and straight.

Grade No. 2—Sub standard—All Patio Tree Roses not meeting The No. 1 Grade Are Defined As Sub Standard.

5.5.3 Mini-tree rose—(miniature varieties)

Grade No.1—Height at least 12 inches (30 cm) or more not to exceed 18 inches (46 cm). Standard size measured at 3 inches (8 cm) below the bud union, shall be at least $\frac{5}{16}$ inches (8.0 mm) in diameter. Bud development (head) shall have at least two bud eyes and shall be well branched in a balanced fashion as defined under sections 5.2, 5.3, and 5.4. Standard cane size shall be upright and straight.

Grade No. 2—Sub standard —All Mini-Tree Roses not meeting the No. 1 Grade are defined as Sub Standard.

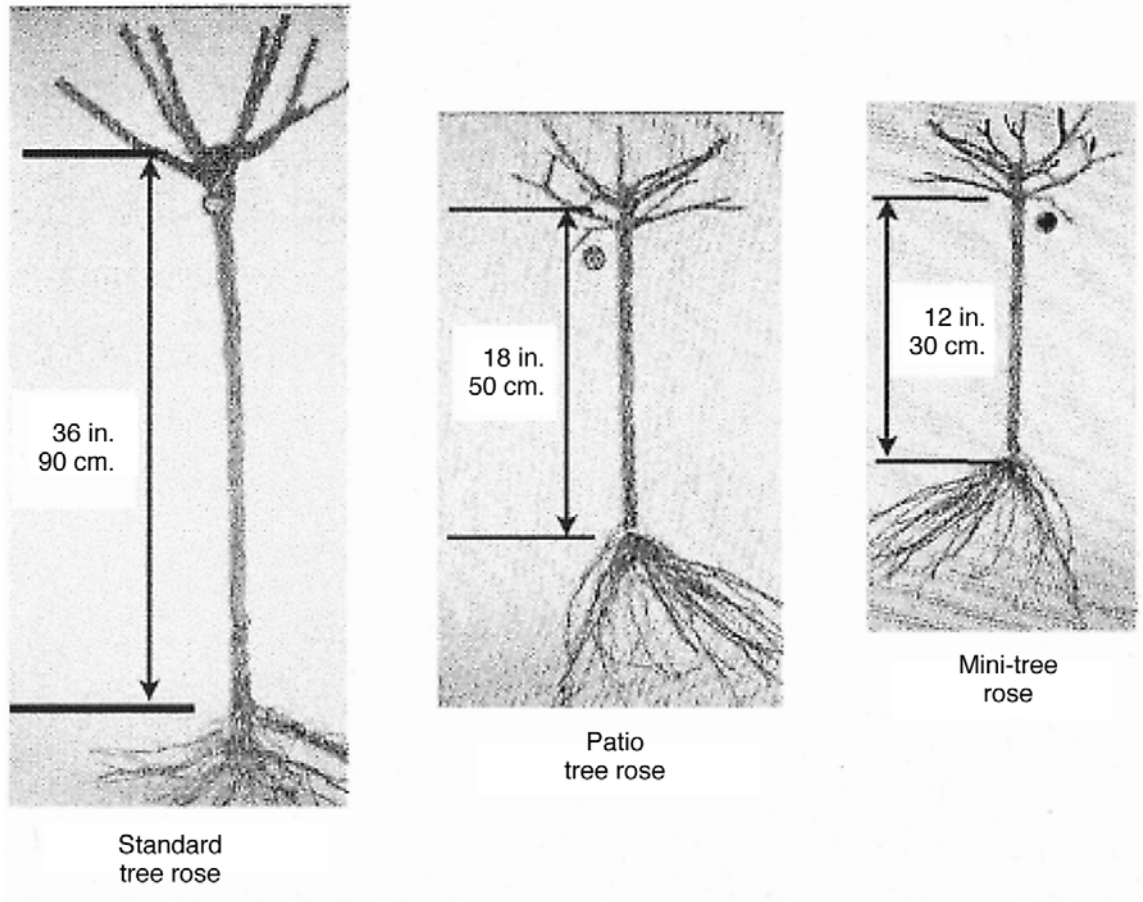

FIGURE 34 – Tree roses

5.6 Container grown roses

All container grown roses shall have been growing in the container in which they are marketed for a minimum of one month of the active growing season and for a maximum of two growing seasons. Roses may be cut back to a minimum of 4 inches (10 cm) above the bud union at the time they are potted and shall comply with the grades in which they are classified prior to pruning in preparation for potting.

All container grown roses should be sold by both rose grade as specified above and by minimum plant container size as specified below. Container sizes shall agree with the container class table in the Foreword.

Rose grade	Minimum container size
No. 1 Grade	#2 Container
No. 1½ Grade	#1 Container
No. 2 Grade	#1 Container

Section 6: Young Plants

This section applies to young plants, including lining out stock, seedlings, whips, ground covers and vines generally sold within the wholesale trade for continued cultivation.

For plants generally sold to the retail and landscape trade, see Section 1 (trees), Section 2 (deciduous shrubs), Section 3 (coniferous evergreens), or Section 4 (broadleaf evergreens), as appropriate.

For understock plants generally graded by caliper, see Section 9.

For seedling trees used for reforestation or restoration purposes, see Section 10.

For ground covers and vines generally sold in #SP4 containers or larger, see Section 12.

6.1 General specifications

Specifications for young plants may include any one or any combination of the following: the cultural history of the plant (see Section 6.1.1), the age of the plant (see Section 6.1.1), or the size of the plant in accordance with the guidelines set forth in Sections 6.2, 6.3, and 6.4. However, exceptions for specifications for unrooted cuttings and micropropagated plants are noted in Section 6.1.3 and 6.1.4, respectively.

Specifications for container grown plants or plants in plug cells should also include the container classification or plug tray specification (See Section 6.6).

The cultural history or age of the plant is not as important when height or caliper is specified, but it may be used in marketing materials or product listings, and may be specified by the purchaser.

6.1.1 Cultural history or age specifications

When specifying plants by the cultural history or age of the plant, each propagation type or cultural history code is followed by the number of years applicable to the code. If age is specified, the age of a young plant is the total of the number of years in the plant history code.

6.1.1.1 Propagation and cultural history codes

<u>Types</u>	<u>Cultural</u>
C = Cutting	R = Root pruned
U = Unrooted cutting	P = Pot or container grown
G = Grafted	T = Transplanted (one T per time)
L = Layered	B = Bed grown
S = Seedling	O = Not transplanted
M = Micropropagated or tissue cultured	
D = Division	

Coll. = Plants collected from the wild shall be so designated.

Examples:

- C1T2 (3-year plant: 1 year in the cutting bench, then transplanted once for 2 years)
- S2T1T1 (4-year plant: 2 years in the seedling bed, transplanted twice for one year each time)
- G1R1 (2-year graft, root pruned after first year).
- M1T1 (2-year plant: 1 year established ex vitro from micropropagation, then transplanted for 1 year)

6.1.2 Quality definition

The quality of all young plants offered is assumed to be normal for the species or variety unless otherwise designated.

6.1.3 Unrooted cuttings

Unrooted cuttings shall be from vigorous healthy plants. They are to be graded by stem caliper, taken at the base of the cutting, and length.

6.1.4 Micropropagated plants (in vitro and ex vitro)

Micropropagated plants shipped from the lab may be specified by stage of growth:

In vitro

Stage II is an unrooted shoot tip, often called a “microcutting.”

Stage III is a rooted shoot tip with two or more roots, often called a “rooted plantlet.”

Ex vitro

After acclimation and establishment in media (soilless mix), micropropagated plants shall be specified in accordance with the appropriate sub-section in the Young Plants section. These plants are usually established in small pots or plug cells.

6.1.5 Pruning

Tops or roots will not be pruned unless specified by the grower or requested by the purchaser.

6.2 Method of measurement

Height measurement is from the ground level to the growing tips. Spread is the average diameter of the top growth.

American Standard for Nursery Stock (ANSI Z60.1-2004)

6.3 Sizing intervals

6.3.1 Slow grower (dwarf and semi-dwarf)

Use 2-in. intervals up to 12 in.

Use 3-in. intervals from 12 in. up.

Examples: *Baptisia australis*, *Berberis thunbergii* var. *atropurpureum* 'Crimson Pygmy,' *Picea abies* 'Pygmaea,' *Sedum*

6.3.2 Medium grower

Use in 3-in. intervals.

Examples: *Achillea* x 'Coronation Gold,' *Rhododendron molle* (Azalea mollis), *Prunus laurocerasus* 'Zabeliana,' *Hedera helix*

6.3.3 Fast grower

Use 6-in. intervals.

Examples: *Acer rubrum*, *Betula pendula*, *Cytisus* 'Burkwoodii,' *Forsythia*, *Pinus* (except dwarf types)

6.4 Types of plants

Using the appropriate measurement interval shown in Section 6.3, above, measure the plants in accordance with the appropriate plant type section, below.

6.4.1 Type 1 - No stems

Measurement designates fullness, spread, root development, or the length of one side or the diameter of the container if the plant substantially fills the soil surface in the container.

Examples: *Ajuga reptans*, *Festuca ovina* var. *glauca*, *Miscanthus sinensis*, *Sagina subulata*, *Sedum*

6.4.2 Type 2 - Single stem

6.4.2.1 Spreading

Measurement designates spread (height not considered).

Examples: *Ceanothus gloriosus*, *Cotoneaster dammeri*, *Erica carnea*, *Juniperus horizontalis* 'Wiltonii,' *Mahonia nervosa*, *Thymus*

6.4.2.2 Semi-spreading

Measurement designates height. Height will usually equal spread.

Examples: *Aquilegia*, *Ilex crenata* 'Helleri,' *Juniperus chinensis* 'Pfitzerana,' *Lavandula*

6.4.2.3 Globe

Measurement designates height.

Examples: *Berberis thunbergii* 'Crimson Pygmy,' *Deutzia gracilis*, *Thuja occidentalis* 'Little Gem,' *Teucrium*

6.4.2.4 Medium upright

Measurement designates height. Height will usually be twice the spread.

Examples: *Chrysanthemum*, *Ilex crenata* 'Rotundifolia,' *Mahonia aquifolium*, *Pieris japonica*, *Rhododendron* (Kurume hybrid) 'Hinodegiri'

6.4.2.5 Upright

Measurement designates height.

Examples: *Acer palmatum*, *Achillea*, *Anemone*, *Betula papyrifera*, *Myrica californica*, *Pseudotsuga menziesii*

6.4.3 Type 3 - Stoloniferous

Measurement designates fullness or number of stolons.

Examples: *Gaultheria procumbens*, *Houttuynia cordata*, *Pachysandra terminalis*, *Vinca minor*

6.4.4 Type 4 - Rhizomatous, tuberous, or fibrous roots

Measurement designates number of eye divisions. See Section 12 for plants generally sold in containers larger than #SP4.

Examples: *Peonies*, *Bleeding Heart*, *Cannas*, *Dahlias*, *Hosta*

6.4.5 Type 5 - Fans

Measurement designates number of fans (stems). Liner grade typically has a single fan or stem. See Section 12 for plants generally sold in containers larger than #SP4.

Examples: *Daylily*, *Iris*

American Standard for Nursery Stock (ANSI Z60.1-2004)

6.4.6 Type 6 - Bulbs, corms

See Section 11.

6.4.7 Type 7 - Vines

Measurement designates length and/or number of runners, and/or container size.

Examples: *Clematis*, *Hedera helix*, *Parthenocissus tricuspidata* 'Veitchii,' *Vitis*, *Wisteria*

6.4.8 Conifer plantation and reforestation plants

Conifer liners for Christmas tree plantation and reforestation uses are graded only by height unless caliper is also specified. When caliper is specified it is by millimeter intervals: 1 mm, 2 mm, 3 mm, 4 mm, 6 mm. See Section 10.

6.5 Unclassified

Any young plant not meeting above specifications should be labeled "Unclassified."

6.6 Plants sold in containers and plug cells

All container grown young plants shall be healthy, vigorous, well rooted, and established in the container in which they are growing. They shall have tops of good quality and be in a healthy growing condition. A container grown young plant shall have a well-established root system reaching the sides of the container to maintain a firm ball.

Specification for young plants sold in containers shall include plant size (height or spread as appropriate for the plant type in Section 6.4, above) and container size. Container sizes shall agree with the Container Class Table in the Foreword.

Groundcovers and vines sold in containers larger than #SP4 should be specified in accordance with Section 12.

6.6.1. Plug cell specifications

A plug tray is a continuous sheet with plug cells that are non-detachable. Specifications should include the number of plug cells per tray and cell size.

Examples: 72 - 1-9/10" x 2-3/16" cells
200 - 1" x 1-1/2" cells
648 - 7/16" x 1/2" cells

Section 7:

Fruit Tree Grades

7.1 General specifications

This section is to cover fruit tree grades.

7.1.1 Quality definition

The quality of fruit tree grades is assumed to be normal for the species or variety unless otherwise designated.

All trees should have reasonably straight trunks according to habit of growth.

7.1.2 Cultural designations

Types

C = Cutting

U = Unrooted cutting

G = Grafted

L = Layered

S = Seedling

M = Micropropagated or tissue cultured

D = Division

Cultural

R = Root pruned

P = Pot or container grown

T = Transplanted (one per time)

B = Bed grown

O = Not transplanted

7.1.2.1 Unrooted cuttings

Unrooted cuttings shall be from vigorous growth and may be graded by caliper and length.

Examples: Apples, plums, cherries

7.1.2.2 Micropropagated plants (*in vitro* and *ex vitro*)

In vitro

Micropropagated plants *in vitro* shall be graded by length. They also may be designated as stage II.

If plants are sold from stage II, they need to be designated rooted or unrooted.

Ex vitro

After rooted, they shall be graded under section 6, Young Plants standards.

7.2 Method of measurement

7.2.1 Deciduous

For purposes of simplicity, only one size per "grade" will be listed. That size will be the minimum size allowable for that "grade" and shall include plants from that size up to, but not including, the next larger grade size.

Example: apple, "Jonathan," standard 3/4-inch caliper. (This could include "Jonathan" apple on standard rootstock caliper at least 3/4-inches, caliper being taken at point indicated below).

7.2.2 General

All grades 5/16-inch and larger should be branched, except one-year Sweet Cherry, and well rooted. The 5/8-inch, 3/4-inch, and 1-inch sizes should have three or more side branches. Caliper should be taken from the collar. The caliper shall govern. The height is here intended to represent average height of most varieties. Slow growing kinds may fall short of height specified.

Age may be given as one year, two years, etc.

It is recognized that "high budding" may be practiced in the nursery to allow for deep planting for tree anchorage, trunk hardiness, etc. In all cases, however, caliper and height shall be established from trunk positions mentioned above.

Exceptions: The following height-caliper relationship shall not be deemed applicable in the case of varieties categorized as genetic mutants. Each of these varieties shall be sized according to varietal characteristics.

Examples: 'Bonanza' dwarf peach, 'Sunburst' dwarf nectarine

Table 29 – Height/caliper relationship for standard Apple, Sweet Cherry, Peach, Almond, Nectarine, Pear, Apricot, Prune, and Plum (one and two years)

Caliper		Height	
Inches	Metric	Feet	Metric
1/4 in.	0.6 cm	2 ft.	60 cm
5/16 in.	0.8 cm	2½ ft.	80 cm
3/8 in.	1.0 cm	3 ft.	90 cm
1/2 in.	1.5 cm	3½ ft.	1.00 m
5/8 in.	1.6 cm	4 ft.	1.25 m
3/4 in.	2.0 cm	5 ft.	1.50 m
7/8 in.	2.2 cm	5½ ft.	1.65 m
1 in. and up	2.5 cm and up	6 ft.	1.80 m

Table 30 – Height/caliper relationship for standard Sour-Cherry and Dwarf Peach, Pear, Nectarine, Apricot, Prune and Plum (on clonal rootstock only):

1/4 in.	0.6 cm	2 ft.	60 cm
5/16 in.	0.8 cm	2½ ft.	80 cm
3/8 in.	1.0 cm	3 ft.	90 cm
1/2 in.	1.5 cm	3½ ft.	1.0 m
5/8 in.	1.6 cm	4 ft.	1.25 m
3/4 in.	2.0 cm	4½ ft.	1.4 m
7/8 in.	2.2 cm	4½ ft.	1.4 m
1 in. and up	2.5 cm and up	5 ft.	1.5 m

Table 31 – Height/caliper relationship for Dwarf Apple (including clonal rootstock and interstem trees)

Caliper		Height	
Inches	Metric	Feet	Metric
1/4 in.	0.6 cm	2 ft.	60 cm
5/16 in.	0.8 cm	3 ft.	90 cm
3/8 in.	1.0 cm	3½ ft.	1.0 m
1/2 in.	1.5 cm	4 ft.	1.25 m
5/8 in.	1.6 cm	4½ ft.	1.4 m
3/4 in.	2.0 cm	5 ft.	1.5 m
7/8 in.	2.2 cm	5 ft.	1.5 m
1 in. and up	2.5 cm and up	5½ ft.	1.65 m

7.2.3 Processed balled

A processed balled fruit tree is one dug bare root, while dormant, and a growing medium mechanically is formed in a ball around the roots.

The minimum ball size specifications for "processed balled" standard and dwarf fruit trees are presented in the following table.

Table 32 – Ball sizes – Processed balled fruit trees

Caliper	Minimum diameter ball
¼ in.	8 in.
5/16 in.	8 in.
3/8 in.	10 in.
½ in.	10 in.
5/8 in.	10 in.
¾ in.	12 in.
1 in. and up	12 in.

7.2.4 Fruit seedlings

7.2.4.1 Caliper measurement

For fruit tree understock grading sizes, see Section 9.3.3.

7.2.4.2 Special specification

In case of seedlings with limbs, there shall be at least 2 inches (5 cm) above the collar free of limbs for a minimum of one-half of the circumference of the seedling.

In case of apple and pear seedlings, where the root description is given as branched or straight, the following shall apply:

Branched Root: Not less than three root branches shall be present within 5 inches (12.5 cm) from the collar.

Straight Root: The root shall carry the minimum caliper of the grade for not less than 6 inches (15 cm) below the collar.

7.2.4.3 Vegetatively propagated/micropropagated fruit stock

In the case of fruit understock grown from "C", "L" or "M" (see Section 7.1.2) the caliper shall be taken on the original cutting or layer at a point 10 inches (25 cm) above the collar.

7.2.4.3.1 Special specification (root system)

All forms of vegetatively propagated fruit rootstocks shall have a minimum of four rootlets on each cutting or layer.

Examples: Malling Merton Nos. 111, 106, M-7A, M-9, M-26, M-27 apple, *Prunus* 'Mariana', and *Prunus cerasifera* (*P. myrobalana*).

Exception: Any rootstocks not meeting the above specifications for root systems shall be labeled as "unclassified" grade and the minimum numbers of rootlets specified.

7.2.5 Citrus

Citrus stocks are to be graded in 1/8-inch increments, beginning with 3/8-inch minimum caliper up to the 3/4-inch size. Recognized grades above 3/4-inch size shall be in increments of 1/4-inch.

Age is to be given in years. Caliper is to be taken 1/2-inch (1.5 cm) above the bud union. Minimum size to be 3/8-inch (1 cm), except that tangerine, mandarin, or lime trees may be sold in 5/16-inch (8 cm) caliper.

7.3 Container grown

All container grown fruit trees shall be healthy, vigorous, well rooted, and established in the container in which they are growing. They shall have tops of good quality (leaf color appropriate for cultivar and no apparent injury) and be in a healthy growing condition. A container grown fruit tree shall have a well-established root system reaching the sides of the container to maintain a firm ball.

All container grown fruit trees sold in containers shall be graded by plant size (height or spread designated), or caliper and container size. Container sizes shall agree with the container class table in the Foreword.

7.4 Size classification of mature trees

The following tables indicate approved marketing nomenclature for specific rootstocks, interstems and rootstock/scion combinations. All sales literature and size claims should be based on these tables.

TABLE 33 - APPLE ROOTSTOCKS/INTERSTEMS

Miniature/very dwarf	Dwarf interstems*	Dwarf	Semi-dwarf	Semi-standard	Standard
EMLA.27	M.9/MM.111	EMLA.9	EMLA.7	EMLA.111	Malus domestica "Yellow Del" CV
P.22	M.9/MM.106	Bud.9	G.30	EMLA.106	Malus domestica "Antanovka" CV
	Bud.9/MM.111	MARK	Ott.3	Bud.118	
	Bud.9/MM.106	EMLA.26	G.11		Malus domestica "Northern Spy" CV
	C-6/seedling	G.16	Supporter@4		
			**NAKB M.9	Spur-Type cultivars grafted on semi-standard & standard rootstock	
		**NIC.29			
		**Pajam.1			
		**Pajam.2			

*Trees grown with dwarf interstem grafted in the trunk between the roots and fruiting scions are categorized in the same size category as if the tree was grown on that root.

**All are clones of M.9

Bud.9=Budagovsky 9

Bud 118=Budagovsky 118

American Standard for Nursery Stock (ANSI Z60.1-2004)

C=Charles Day

EMLA=East Malling Lansing

G=Geneva

MARK=Mac 9

MM.106=Malling-

Merton 106

Ott.3=Ottawa 3

P.22=Polish 22

The above Table 33 illustrates relative dwarfing induced to a fruiting variety by the process of grafting onto a rootstock compared to the same variety grafted onto a rootstock of standard size.

TABLE 34 - PEAR ROOTSTOCKS

Dwarf	Semi-dwarf	Semi-standard	Standard
EMLA Quince A	OhxF333	OHxF97	Pyrus betulaefolia seedling
EMLA Quince C	OHxF40 (Brooks™ selections)	OHxF217	Pyrus ussuriensis seedling
	Province Quince	OHxF87 (Brooks™ selections)	Pyrus communis seedling
	BA-29 Quince		Pyrus calleryana seedling
	Pyrodwarf®		Bien Donne™ 3
	Bien Donne™ 1		Pyrus Winter Nelis seedling

OHxF=Old Home x Farmingdale

EMLA=East Malling Lansing

The above Table 34 illustrates relative dwarfing induced to a fruiting variety by the process of grafting onto a rootstock compared to the same variety grafted onto a rootstock of standard size.

TABLE 35 – PEACH, NECTARINE, AND ALMOND ROOTSTOCKS

Genetic dwarf	Dwarf	Semi-dwarf	Semi-standard	Standard
Cultivars that are genetically less than 50 percent of standard size peach regardless of rootstock <i>Examples:</i> Honey babe Peach Nectar Babe Nectarine Garden Prince Almond	Prunus Pumiselect™	EMLA St. Julian A	Nemaguard seedling	*‘Hansen’ 536
		Citation	Prunus persica ‘Lovell’ seedling	*Paramount™ GF677 CV
		Jaspi™ Fereley CV	Ishtara™ Ferciana CV	*Cadaman™ Avimag CV
		Julior™ Ferdor CV		*Viking
		Prunus St. Julian Inra.2		*Barrier™ *Atlas

*Clonal – peach x almond hybrids

The above Table 35 illustrates relative dwarfing induced to a fruiting variety by the process of grafting onto a rootstock compared to the same variety grafted onto a rootstock of standard size.

TABLE 36 – PLUM AND APRICOT ROOTSTOCKS

Dwarf	Semi-dwarf	Semi-standard	Standard
Pixy®	EMLA St. Julian A	Marianna 26-24	Prunus persica 'Lovell' seedling
Prunus Pumiselct™	Stark® Redleaf Peach	Torianel™ Avifel CV	Prunus cerasifera Myrobalan seedling
	Citation	Ishtara™ Ferciana CV	Prunus americana
	Prunus St. Julian A Inra.2 seeding	Marianna M.40 CV	Prunus armeniaca Apricot seedling
	Jaspi™ Fereley CV		Myrobalan H29-C
	Julior™ Ferdor CV		Marianna 4001
			Marianna GF8-1
			Nemaguard seedling

TABLE 37 – CHERRY ROOTSTOCKS

Dwarf	Semi-dwarf	Semi-standard	Standard
Gisela™5	Gisela™12	Gisela™6	Prunus avium (Mazzard seedling)
GM 61/1 Damil CV	Maxma™14	Mahaleb seedling	Prunus avium F 12/1
	Brokforest CV	EMLA Colt	
		MxM™6	
		MxM™2	

The above Table 37 illustrates relative dwarfing induced to a fruiting variety by the process of grafting onto a rootstock compared to the same variety grafted onto a rootstock of standard size.

Section 8:

Small Fruits

8.1 General specifications

This section is to cover small fruits.

8.1.1 Quality definitions

The quality of small fruits is assumed to be normal for the species or variety unless otherwise designated.

All small fruit plants shall be well rooted. No injured, stunted, or odd shaped plants shall be included in any grade.

8.1.2 Designation

Types

C = Cutting

U = Unrooted cutting

G = Grafted

L = Layered

S = Seedling

M = Micropropagated or tissue cultured

D = Division

Cultural

R = Root pruned

P = Pot or container grown

T = Transplanted (one per time)

B = Bed grown

O = Not transplanted

8.1.2.1 Unrooted cuttings

Unrooted cuttings shall be from vigorous growth and may be graded by caliper and length.

Examples: Gooseberries, currants, blueberries.

8.1.2.2 Micropropagated plants (in vitro and ex vitro)

In vitro

Micropropagated plants in vitro shall be graded by length.

They also may be designated as stage II.

If plants are sold from stage II, they need to be designated rooted or unrooted.

Ex vitro

After rooted, they shall be graded under section 6, Young Plants standards.

8.2 Method of measurement

8.2.1 Raspberries

8.2.1.1 Sucker and root cutting plants

Grade No. 1—Sucker and root cutting plants, also tip plants, should be graded $\frac{3}{16}$ inch and up in caliper at collar; sucker plants should have 10 inches or more of live top; tip plants, 8 inches or more live tops; and well rooted with at least one cross root below crown, i.e., “L” or “T” root(s).

Grade No. 2—Sucker and root cutting plants, also tip plants, $\frac{1}{8}$ inch and up caliper at collar; sucker and root cutting plants to have 8 inches or more of live top; tip plants, 6 inches or more of live tops, and all proportionately well rooted.

8.2.2 Transplanted raspberries

Grade No. 1—All transplanted raspberries should caliper $\frac{1}{4}$ inch and up at collar and have 12 inches or more of live top, and be well rooted.

Grade No. 2—Number two shall caliper $\frac{3}{16}$ inch and up with 12 inches or more of live top, and be well rooted with at least one cross root below crown, i.e., “L” or “T” root(s).

8.2.3 Dewberries, blackberries, boysenberries, youngberries

8.2.3.1 Root cuttings

Grade No. 1—Root cuttings should caliper $\frac{1}{8}$ inch and sucker plants should caliper $\frac{3}{16}$ inch and up at collar and have 12 inches or more of live top, and be well rooted.

Grade No. 2—Root cuttings should caliper $\frac{3}{32}$ inch and up and sucker plants should caliper $\frac{1}{8}$ inch and up at collar and have 8 inches or more of live top, and be proportionately well rooted.

8.2.4 Transplanted blackberries

Grade No. 1—Should caliper $\frac{1}{4}$ inch and up at collar and have 12 inches or more of live top, and be well rooted.

8.2.5 Currants

Grade 2 Yr. No. 1—Shall measure 12 inches and up in height, with two or more branches, and be well rooted.

Grade 1 Yr. No. 1—Shall measure 9 inches and up in height; if single-cane plants, to be 12 inches high, and be well rooted.

Grade 2 Yr. No. 2—Same specifications as 1 Yr. No. 1.

8.2.6 Blueberries

All measurements to indicate overall height of plant from crown to tip of plants. All well branched in proportion to height. For purposes of simplicity, only one size per “grade” will be listed. That size will be the minimum size allowable for that “grade” and shall include plants from that size up to, but not including, the next larger grade size.

- 1-year Rooted Cuttings 3 in.
- 2-year 9 in.
- 3-year 12 in.
- 4-year 18 in.

8.2.7 Gooseberries

Grade 2 Yr. No. 1—Shall measure 12 inches and up in height, with three or more canes, or equivalent side branches, and be well rooted.

Grade 1 Yr. No. 1—Shall measure 8 inches and up in height, with two or more branches, or equivalent side branches, and be well rooted.

Grade 2 Yr. No. 2—Same specifications as 1 Yr. No. 1

8.2.8 Grape vines

Grading of grape vines is based mainly on root system.

Grade 2 Yr. No. 1—The lightest growing varieties should have 12 inches or more of live top; stronger growing varieties should be proportionately larger and all well rooted.

Grade 1 Yr. No. 1—Lightest growers should have 6 inches or more of live top; stronger growers should be proportionately larger and all be well rooted.

Grade 2 Yr. No. 2—Same specifications as 1 Yr. No. 1

8.2.9 Strawberry plants

Minimum grade—There shall be at least 10 main roots, not less than 3 inches long, and a minimum crown diameter of $\frac{5}{16}$ inch measured at the base.

8.2.10 Asparagus crowns

1 Yr. No. 1—Shall not weigh less than 60 pounds per one thousand (1000) plant. Fifty percent of the root system shall exceed 5 inches in length.

2 Yr. No. 1—Shall not weigh less than 120 pounds per 1000 plants. Fifty percent of the root system shall exceed 7 inches in length.

2 Yr. No. 2—Shall not weigh less than 60 pounds per 1000 plants. Fifty percent of the root system shall exceed 5 inches in length.

3 and 4 Yr. No. 1—Shall not weigh less than 200 pounds per 1000 plants. Fifty percent of the root system shall exceed 10 inches in length.

8.3 Container grown

All container grown small fruits shall be healthy, vigorous, well rooted, and established in the container in which they are growing. They shall have tops of good quality (leaf color appropriate for cultivar and no apparent injury) and be in a healthy growing condition. A container grown small fruit plant shall have a well-established root system reaching the sides of the container to maintain a firm ball.

All container grown small fruits sold in containers shall be graded by plant size (height or spread designated) or caliper, and container size. Container sizes shall agree with the container class table in the Foreword.

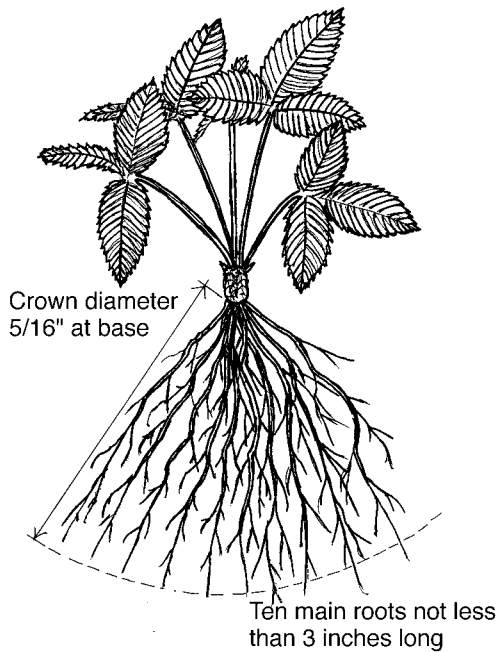

FIGURE 35 – Strawberries – minimum requirements

Section 9: Understock

9.1 General specifications

This section is to cover plants (primarily shade, flowering, fruit, and nut trees) graded by caliper generally used for grafting and budding. (For plants graded by height, see Section 6.)

9.1.1 Quality definition

The quality of all understock offered is assumed to be normal for the species or variety unless otherwise designated. It is essential that the stem be reasonably straight.

Tops or roots may be trimmed as specified by grower or requested by purchaser.

Evergreens should be transplanted frequently enough to create a good root system.

In order to produce a fibrous root system, species such as firs, pines, and similar sorts, which normally make a few coarse roots, should be transplanted every two years, and species such as *Arborvitae* should be transplanted every three years, as they naturally make better roots.

Broad-leaved evergreen species such as *Pyracantha coccinea* 'Lalandei,' which normally make a few coarse roots, should be transplanted every year, while those producing a good system of fibrous roots may be transplanted every second year.

9.1.2 Designation

Types

C = Cutting

U = Unrooted cutting

L = Layered

S = Seedling

M = Micropropagated or tissue cultured

D = Division

Cultural

R = Root pruned

P = Pot or container grown

T = Transplanted (one per time)

B = Bed grown

O = Not transplanted

9.1.2.1 Unrooted cuttings

Unrooted cuttings shall be from vigorous growth and may be graded by caliper, taken at the base of the cutting, and length.

9.2 Method of measurement

Caliper shall be taken at the collar or ground line unless height is specified by purchaser, who shall indicate if he or she wants height only or height and caliper.

Age is not important when caliper is specified; however, it may be requested by purchaser.

9.2.1 Measurement designation

1/16 in.	(1.5 mm)
1/8 in.	(3 mm)
3/16 in.	(5 mm)
1/4 in.	(7 mm)
3/8 in.	(10 mm)
1/2 in.	(1.5 cm)
5/8 in.	(1.6 cm)
3/4 in.	(2 cm)
1 in.	(2.5 cm)

9.3 Types of plants

9.3.1 Fruit and nut seedlings—seed-propagated stock

Exception: 3/16-inch “straight” of Apple seedlings shall be graded from 3/16-inch (5.0 mm) up to but not including 3/8-inch (1.0 cm) caliper.

9.3.1.1 Seedlings with limbs

There will be no limbs on one side of the seedling for at least 2 inches above the collar to ensure a budding or grafting area.

9.3.1.2 Root descriptions

In case of Apple and Pear seedlings, where the root description is given as branched or straight, the following shall apply:

Branched root: Not less than three root branches shall be present with 5 inches (13 cm).

Straight root: The root shall carry the minimum caliper of the grade for not less than 6 inches (15 cm) from the collar.

9.3.2 Vegetatively propagated plants

9.3.2.1 From layering

Stem caliper shall be taken 10 inches above the bottom of the layer (basal cut).

Roots—a minimum of 3 root nodes, each node containing at least 1 root.

9.3.2.2. Hardwood cuttings

On original hardwood cuttings, caliper is taken at the top of the cutting.

On cuttings with new growth above the original hardwood cutting, caliper and length are taken two inches up on the new growth.

9.3.2.3 Softwood cuttings

Caliper shall be taken at the collar or ground line.

9.3.2.4 Micropropagated plants (in vitro and ex vitro)

In vitro

Micropropagated plants in vitro shall be graded by length. They also may be designated as stage II.

If plants are sold from stage II, they need to be designated rooted or unrooted.

Ex vitro

After rooted, they shall be graded under the Young Plants standards.

9.3.3 Unclassified

Any rootstocks not meeting the above specifications should be labeled “unclassified.”

9.4 Evergreen lining out stock—recommendations

Evergreens should be transplanted frequently enough to create a good root system, which will ensure a minimum of transplanting loss, and to give the top room enough to start the branch framework properly, making a well-shaped specimen when placed in the nursery row.

In order to produce a fibrous root system, species such as *Abies*, *Pinus*, and similar sorts, which normally make a few coarse roots, should be transplanted every two to three years, and species such as *Arborvitae* and *Chamaecyparis* should be transplanted every three to four years, as they naturally make better roots.

Broad leaved evergreen species such as *Pyracantha coccinea* ‘Lalandei,’ which normally make a few coarse roots, should be transplanted every year, while those producing a good system of fibrous roots may be transplanted every second year only.

Trimming is also necessary to ensure a proper foundation for a good shape in the finished plant, although frequent transplanting will usually avoid the necessity of severe trimming.

9.5 Shade and flowering tree seedlings

Caliper shall be taken at the collar or ground line and grades shall correspond to the following calipers:

1/16 in.	1/8 in.	1/4 in.
3/32 in.	3/16 in.	3/8 in.

9.6 Container grown

All container grown understock shall be healthy, vigorous, well rooted, and established in the container in which they are growing. They shall have tops of good quality (leaf color appropriate for cultivar and no apparent injury) and be in a healthy growing condition. Container grown understock shall be containerized a sufficient time so as to have a well-established root system reaching the sides of the container to maintain a firm ball.

All container grown understock sold in containers shall be graded by caliper (except micropropagated plants, see section 9.3.2.4), and container size. Container sizes shall agree with the container class table in the Foreword.

Section 10: Seedling Trees and Shrubs

10.1 General specifications

This section is to cover plants used for forest, game refuge, erosion control, shelterbelt, or farm woodlot plantings. For general listing, see Young Plants, Section 6.

10.1.1. Quality definition

The quality of all seedling trees and shrubs is assumed to be normal for the species or variety unless otherwise designated. All plants are to have developed root systems, to be free of insects and diseases as well as mechanical injuries, and in all respects to be suitable for field planting. All conifers shall have dormant buds (except in the South) and secondary needles.

At the option of the purchaser, other special restrictions may be specified.

Tops or roots will not be trimmed unless specified by grower or requested by purchaser.

10.1.2. Designation

Types _____

C = Cutting

U = Unrooted cutting

G = Grafted

L = Layered

S = Seedling

M = Micropropagated or tissue cultured

D = Division

Cultural

R = Root pruned

P = Pot or container grown

T = Transplanted (one per time)

B = Bed grown

O = Not transplanted

Coll. = Plants collected from the wild shall be so designated.

Age = Sum of numbers following above codes.

Example: S2T1T1 (4-year plant, 2 years in seedling bed, transplanted twice, one year each transplanting).

10.2 Method of measurement

Age is not important when height or caliper is specified; however, it may be used in listings or demanded by purchaser.

When caliper is important, measurements are taken at root collar or ground line.

10.2.1. Deciduous or hardwood

When heights are to govern, the caliper specification is minimum, and when caliper is to govern, the height specification is minimum.

Table 38–Minimum heights and root lengths for seedling calipers

Caliper	Min. height	Min. root length
1/16 in.	3 in.	4 in.
3/32 in.	3 in.	5 in.
1/8 in.	6 in.	6 in.
3/16 in.	12 in.	8 in.
¼ in.	18 in.	10 in.
3/8 in.	24 in.	12 in.

Table 39–Minimum calipers for seedling heights* and root lengths

Height	Min. caliper	Min. root length
3 in.	1/16 in.	4 in.
6 in.	1/16 in.	4 in.
12 in.	3/32 in.	5 in.
18 in.	1/8 in.	6 in.
2 ft.	3/16 in.	8 in.
3 ft.	¼ in.	10 in.
4 ft.	3/8 in.	10 in.
5 ft.	7/16 in.	12 in.

*Suggested for commercial nurseries furnishing or purchasing stock for the retail trade, and still comply with demands for calipered stock.

10.2.2 Coniferous evergreens

For coniferous evergreens, height shall govern.

Table 40—Coniferous evergreen seedlings

Height	Min. caliper
6 in.	1/16 in.
9 in.	1/8 in.
12 in.	3/16 in.

10.3. Container grown

All container grown seedling trees and shrubs shall be healthy, vigorous, well rooted, and established in the container in which they are growing. They shall have tops of good quality and be in a healthy growing condition. A container grown young plant shall be in that container a sufficient time that fibrous roots are formed so the shape will remain and the medium will hold together when removed from the container.

All container growing seedling trees and shrubs sold in containers shall be graded by plant size or caliper, and container size. Container sizes shall agree with the container class table on page ii of the Foreword.

Section 11: Bulbs, Corms, and Tubers

11.1 General

Bulbs and corms are generally sold under grade names such as “forcing size,” “top-size,” “large,” etc. In the case of narcissus and daffodils, the designations of “double nose,” to indicate a split bulb, and “round,” are used.

With some groups, such as hyacinths, the grade names indicate usage; for example, “exhibition” and “forcing” sizes, and sizes more suitable for outdoor bedding purposes.

At the grower and wholesale levels, where more precise size information is imperative, actual size in inches or centimeters has been standard in the trade. With the need for international uniformity, size designations in most instances will be expressed in centimeters in circumference. In some instances this type of measurement is not feasible (e.g., daffodils, peonies, caladiums, etc.), and another criterion (e.g., weight) is used.

11.2 Amaryllis

Designated by centimeters or inches of circumference.

Jumbo	36 cm. and up	(14 ¼ in. and up)
Exhibition	32 cm.	(12 ¾ in.)
Fancy	30 cm.	(12 in.)
Large	26 cm.	(10 ¼ in.)
Medium	22 cm.	(8 ¾ in.)
Small	20 cm.	(8 in.)

11.3 Anenomes

Designated by centimeters or inches of diameter.

Extra large	7 cm.	(2 ¾ in. and up)
Large	6 cm.	(2 ½ in.)
Medium	5 cm.	(2 in.)
Small	4 cm.	(1 ½ in.)

11.4 Begonias (tuberous)

Designated by centimeters or inches of diameter.

Giant	6 cm. and up	(2 ½ in. and up)
Extra large	5 cm.	(2 in.)
Large	4 cm.	(1 ½ in.)
Medium	3 cm.	(1 ¼ in.)
Small	2 cm.	(¾ in.)

11.5 Caladiums

Designated by centimeters or inches of diameter.

Giant	8 cm. and up	(3 in. and up)
Large	6 cm.	(2 ½ in.)
Standard	5 cm.	(2 in.)
Medium	4 cm.	(1 ½ in.)
Small	2 cm.	(¾ in.)

11.6 Callas

Designated by centimeters or inches of diameter.

Top	19 cm. and up	(7 ½ in. and up)
Large	5 cm.	(2 in.)
Medium	4 cm.	(1 ½ in.)
Small	3 cm.	(1 ¼ in.)

11.7 Cannas

Number of “eyes” or “buds” per root to be indicated. Any root with less than 2 “eyes” should not be offered to the public, but may be suitable for growing on in the nursery, or for potting or bedding purposes.

11.8 Crocosmia

Designated by centimeters or inches of circumference.

Large	10 cm. and up	(4 in. and up)
Medium	6 – 8 cm.	(2 ½ - 3 in.)

11.9 Crocus

Designated by centimeters or inches of circumference.

Top	9 cm. and up	(3 ½ in. and up)
Large	8 cm.	(3 in.)
Medium	7 cm.	(2 ¾ in.)
Small	6 cm.	(2 ½ in.)

11.10 Dahlias

Designated by weight in grams. Each division shall have a portion of live crown and at least 1 “eye” or “bud.”

No. 1	100 grams (or more)
No. 2	80 grams

11.11 Freesias

Designated by centimeters or inches of diameter.

Extra large	7 cm.	(2 ¾ in. and up)
Large	6 cm.	(2 ½ in.)
Medium	5 cm.	(2 in.)
Small	4 cm.	(1 ½ in.)

11.12 Gladiolus

Designated by centimeters or inches of circumference.

Jumbo	14 cm. and up	(5 ½ in. and up)
Large No. 1	12 cm.	(4 ¾ in.)
Large No. 2	10 cm.	(4 in.)
Medium No. 3	8 cm.	(3 in.)
Medium No. 4	6 cm.	(2 ½ in.)
Small No. 5	4 cm.	(1 ½ in.)
Small No. 6	3 cm.	(1 ¼ in.)
No Grade/No. 7	Under 3 cm.	(Under 1 ¼ in.)

11.13 Gloxinia (tuberous)

Designated by centimeters or inches of diameter.

Giant	6 cm. and up	(2 ½ in. and up)
Extra large	5 cm.	(2 in.)
Large	4 cm.	(1 ½ in.)
Medium	3 cm.	(1 ¼ in.)
Small	2 cm.	(¾ in.)

11.14 Hyacinths

Designated by centimeters or inches of circumference.

Top forcing	19 cm. and up	(7 ½ in. and up)
Large forcing	18 cm.	(7 in.)
Medium forcing	17 cm.	(6 ¾ in.)
Top bedding	16 cm.	(6 3/8 in.)
Large bedding	15 cm.	(6 in.)
Medium bedding	14 cm.	(5 ½ in.)

11.15 Iris - Dutch iris

Designated by centimeters or inches in circumference.

For large bulb varieties such as 'Wedgewood,' 'Ideal,' 'Prof. Blaauw,' and 'Blue Magic':

Top	10 cm. and up	(4 in. and up)
Large	9 cm.	(3 ½ in.)
Medium	8 cm.	(3 in.)

For smaller bulb varieties such as 'Excelsior,' 'White Van Vliet,' 'Imperator,' 'Golden Harvest,' 'H.C. Van Vliet,' and 'White Perfection':

Top	8 cm. and up	(3 in. and up)
Large	7 cm.	(2 ¾ in.)
Medium	6 cm.	(2 ½ in.)

11.16 Liatris

Designated by centimeters or inches of circumference

No. 1 Flowering Size	10 cm. and up (4 in. and up)
No. 2 Liner Size	8 cm. (3 in.)

11.17 Lilies

Designated by centimeters or inches of circumference. Various species of lilies produce different size bulbs. These generally fall into two groups: the large bulb species such as ‘Regal’ and ‘Easter’; and the smaller bulb species such as ‘Tigrinum,’ ‘Umbellatum,’ and ‘Midcentury.’

Large Bulb Species	Smaller Bulb Species
24 cm. (9 ½ in.)	18 cm. (7 in. and up)
22 cm. (8 ¾ in.)	16 cm. (6 ³ / ₈ in.)
20 cm. (8 in.)	14 cm. (5 ½ in.)
18 cm. (7 1/8 in.)	12 cm. (4 ¾ in.)
16 cm. (6 ³ / ₈ in.)	10 cm. (4 in.)

11.18 Muscari (grape hyacinths)

Designated by centimeters or inches of circumference.

Top	9 cm. and up (3 ½ in. and up)
Large	8 cm. (3 in.)
Medium	7 cm. (2 ¾ in.)

11.19 Narcissus and daffodils

Narcissus bulbs are designated either as “double nose” (DN) or “round” (RN), and should be size-graded as DN I, DN II, DN III, or RN I, RN II, or RN III, or by using the appropriate “Top,” “Large,” or “Medium” designations, as shown below.

11.19.1 – Double nose

Double nose means that bulbs show evidence of producing two or more flowers. Due to the double character of the bulb, circumference measurements cannot be used. *Size designation of DN bulbs is determined by the number of bulbs required to fill a 50-liter basket (500 cm³).* Some cultivars tend to be larger than the average (e.g., “E.H. Krelage,” “Sempre Avanti”) or smaller than the average (e.g., “Poeticus,” “White Sail”).

American Standard for Nursery Stock (ANSI Z60.1-2004)

The following chart shows examples of the number of DN bulbs per 50-liter basket for each size designation:

	(Size)		
	Top	Large	Med.
	DN I	DN II	DN III
Trumpet	200	275	375
'E.H. Krelage'	175	250	350
'Magnificence'	250	325	450
Large Cup	200	275	375
'Fortune'	225	300	400
'Sempre Avanti'	175	250	350
Small Cup	300	400	550
'Barret Browning'	200	275	375
'Verger'	275	350	450
Tazetta	275	350	475
'Geranium'	250	325	450
Poeticus	400	550	700
'Actea'	275	350	475
Double	300	400	550
'Cheerfulness'	275	350	475
'Texas'	250	325	450
'White Sail'	400	550	700

11.19.2 - Round

Round means single-nosed bulbs which are fairly circular in cross-section.

While size may vary from the norm for certain cultivars, generally the sizes are:

RD I Top	14 cm. and up	(5 ½ in. and up)
RD II Large	12 cm.	(4 ¾ in.)
RD III Medium	10 cm.	(4 in.)

11.20 Narcissus—paper white

A type of bulb normally much smaller than other types of narcissus.

Designated by centimeters or inches of circumference.

Top	16 cm. and up	(6 ³ / ₈ in. and up)
Large	15 cm.	(6 in.)
Medium	14 cm.	(5 ½ in.)
Small	12 cm.	(4 ¾ in.)

11.21 Ranunculus

Designated by centimeters or inches of diameter.

Giant	8 cm.	(3 in. and up)
Extra large	7 cm.	(2 ¾ in.)
Large	6 cm.	(2 ½ in.)
Medium	5 cm.	(2 in.)
Small	4 cm.	(1 ½ in.)

11.22 Tulips

Designated by centimeters or inches of circumference.

Top	12 cm. and up	(4 ¾ in. and up)
Large	11 cm.	(4 ½ in.)
Medium	10 cm.	(4 in.)
Small	9 cm.	(3 ½ in.)

11.23 Tuberoses

Designated by centimeters or inches of diameter.

Top	19 cm. and up	(4 in. and up)
First	8 cm.	(3 in.)

Section 12: Herbaceous Perennials, Ornamental Grasses, Groundcovers, and Vines

This section applies to plants generally sold to the retail and landscape trade. For lining out stock sold within the wholesale trade for continued cultivation, or for plants listed in this section sold in containers smaller than #SP4, see Section 6.

12.1 General specifications

Plants in this section should be specified by the form in which they are marketed: container grown, bare root, or field potted (see Section 12.1.1).

Specifications for certain container grown plants in this section shall include both plant size and container size, while specifications for other container grown plants in this section may include only container size. Even when only container size is required, specifiers are encouraged to also include a minimum plant size.

Propagation methods (Section 12.1.2) may also be specified.

12.1.1 Types (form in which marketed):

Container-grown—grown to a specified size in a container. Specify by indicating container class from the table in the Foreword.

Bare root—free or substantially free of any soil or growing media. Specify as “BR.”

Field-potted—field-grown plants which are potted for delivery as they are dug from the field. Specify as “FP.”

12.1.2 Propagation methods

The following codes should be used to designate propagation methods.

D = division

S = seedling

C = cutting

G = grafted

L = layered

M = micropropagated or tissue cultured

Coll. = Individual plants collected directly from the wild or collected from the wild and grown on in a nursery.

12.1.3 Container grown plants

All container grown plants shall be healthy, vigorous, well rooted, and established in the container in which they are growing. A container grown plant shall have a well-established root system reaching the sides of the container to maintain a firm root ball, but shall not have excessive root growth encircling the inside of the container.

12.2 Herbaceous perennials sold by eye divisions, fans, or rhizomes

Specifications for plants included in this section shall include both plant size and container size. Specific standards are used for these perennials due to certain rhizomatous, tuberous or other growth habits. Container sizes indicated are recommended minimums for the listed plant size.

12.2.1 *Astilbe*

- 1-2 eye division: #SP4 container
- 2-3 eye division: #SP5 container
- 3-5 eye division: #1 container
- 5 eye and larger: #2 container

12.2.2 *Dicentra*—Bleeding Heart

- 1-2 eye division: #SP4 container
- 2-3 eye division: #SP5 container
- 3-5 eye division: #1 container
- 5 eye and larger: #2 container

12.2.3 *Hemerocallis*—Daylily

- 1-fan (stem) division, blooming size: #SP4 container
- 1 or 2 fan (stem) division, heavy root system: #SP5 container

Fan (stem) divisions of dwarf and miniature Daylilies are usually smaller than normal, while those of tetraploid Daylilies are generally larger.

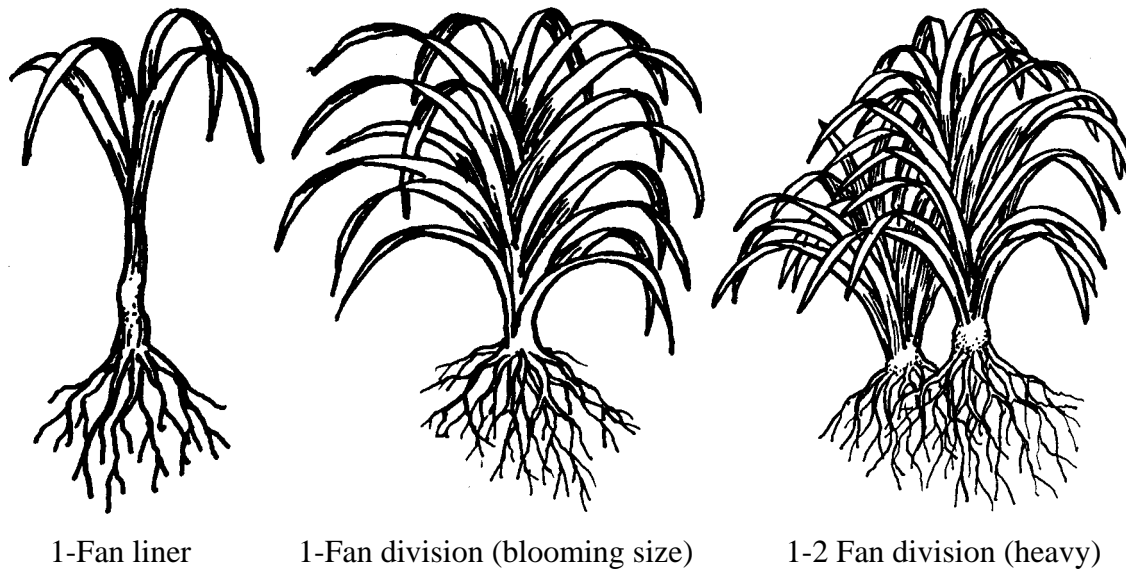

FIGURE 36 – Examples of typical grades for *Hemerocallis*

12.2.4 *Hosta* ssp.—*Funkia*

- 1 eye, light grade: #SP4 container
- 1 eye, heavy grade (well rooted): #SP5 container
- 1-2 eye, heavy grade: #1 container

12.2.5 *Iris*

Iris ensata (Japanese Iris) and *Iris sibirica* (Siberian Iris):

- 1-2 fan (stem) division (at least 1 fan blooming size): #SP4 container
- 2-3 fan (stem) heavy blooming size division: #1 container

Bearded Iris—Dwarf, intermediate, and tall classifications:

- Small non-blooming size rhizome: #SP4 container
- Large blooming size rhizome: #SP5 container

12.2.6 *Paeonia*—*Peony*

- 2-3 eye division: #SP5 container
- 3-5 eye division: #1 container
- 5 eye and up: #2 container

All eyes counted shall be flowering eyes, or large nonflowering eyes on heavy roots. Small “eye” buds shall not be counted.

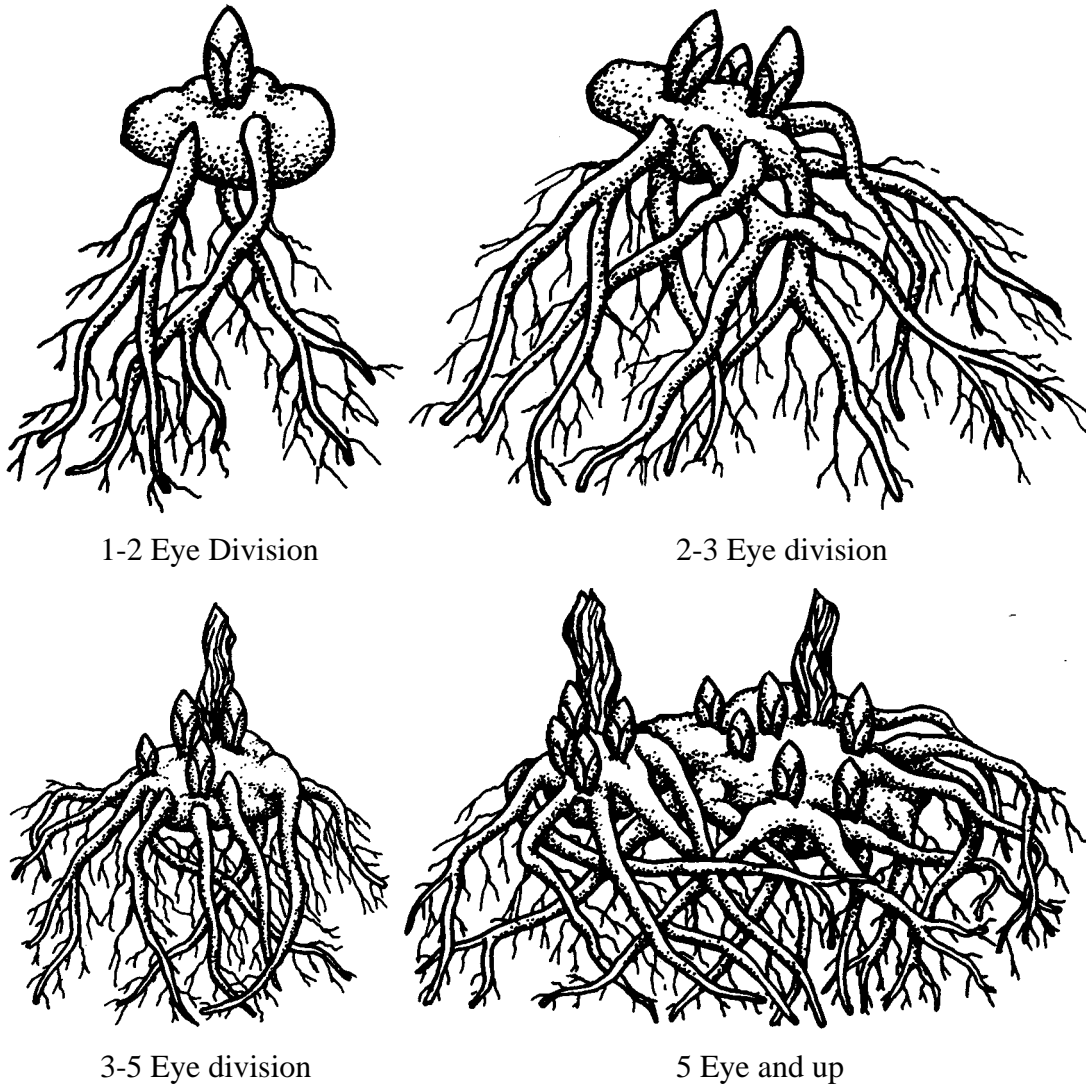

FIGURE 37 – Examples of typical sizes for *Paeonia*

12.2.7 *Papaver orientale*—Oriental Poppy

Light one-year plant:	#SP4 container
Heavy one-year plant (bare root, field-grown):	#SP5 container

12.3 Other herbaceous perennials

Herbaceous perennials not included in Section 12.2, above, shall be specified and sold by container class as shown in the container classification table in the Foreword. The root mass of the plant shall satisfy the requirement stated in Section 12.1.3, above.

Examples: Echinacea, Gaura, Penstemon, Rudbeckia, Salvia, Veronica

12.4 Ornamental grasses

Ornamental grasses shall be specified and sold by container class as shown in the container classification table in the Foreword. The root mass of the plant shall satisfy the requirement stated in Section 12.1.3, above.

Examples: Cortaderia, Festuca, Miscanthus, Muhlenbergia, Panicum, Pennisetum

12.5 Groundcovers

Groundcovers shall be specified and sold by container class as shown in the container classification table in the Foreword. The root mass of the plant shall satisfy the requirement stated in Section 12.1.3, above. It may be helpful to include additional information in the specification, such as the number of runners. For plants sold in containers smaller than an #SP4, see Section 6.

Examples: Ajuga reptans, Dalea greggii, Gazania rigens, Lantana montevidensis, Liriope, Lonicera japonica, Pachysandra procumbens, Vinca minor

12.6 Vines

Specifications for vines may include stake height, if applicable, or minimum length, and container class as shown in the container classification table in the Foreword. The root mass of the plant shall satisfy the requirement stated in Section 12.1.3, above. The longest trail of the vine shall reach at least the length of the stake (e.g., “Hedera helix, staked, 18” ht., #2)

Examples: Bougainvillea, Campsis radicans, Clematis, Hedera helix, Macfadyena unguis-cati, Parthenocissus, Tecomaria capensis

SECTION 13:

CHRISTMAS TREE STANDARDS

The standard herewith shall conform to the standards promulgated by the United States Department of Agriculture, effective April 1, 1973, and as thereafter may be revised. These standards are based on the factors of density, taper, balance, foliage, and deformities and are classified as U.S. Premium, U.S. No. 1 or U.S. Choice, U.S. No. 2 or U.S. Standard, and Culls. Copies of these standards are available from the Fresh Products Branch, Fruit and Vegetable Quality Division, Food Safety and Quality Service, U.S. Department of Agriculture, Washington, DC 20250.

APPENDIX A: GLOSSARY

BALLED & BURLAPPED (B & B). Plants established in the ground which have been prepared for transplanting by digging so that the soil immediately around the roots remains undisturbed. The ball of earth containing the roots of the plant is then bound up in burlap or similar mesh fabrics.

BALLED AND POTTED (B & P). Plants dug with a ball of earth and placed in a container in lieu of burlapping.

BARE -ROOT (B.R.). Harvested plants from which the soil or growing medium has been removed.

BRANCH. An outgrowing shoot, stem or twig that grows from the main stem or trunk.

CALIPER. In the landscape or nursery trade, this is the diameter of a tree, measured at a point 6 inches above the ground line if the resulting measurement is no more than 4 inches. If the resulting measurement is more than 4 inches, the measurement is made at a point 12 inches above the ground line. This in contrast to the method used to measure caliper in the timber industry, which is to make the measurement at a point 4½ feet above the ground line, or the "diameter breast height" (DBH).

CANE. A primary stem which starts at a point not higher than ¼ the height of the plant.

COLLAR. The line of junction between the root of a plant and its stem or trunk. Also called "Root Collar."

COLLECTED PLANT. A plant that has been gathered from the wild or taken from an established landscape planting; not grown in a nursery.

CONTAINER. A flat, pot, tub, etc., usually made of plastic, wood, ceramic, or metal, used to grow or hold one or more plants and which generally prevents the growth of roots beyond its side walls or bottom. (See "Grow Bag," below).

CONTAINER GROWN PLANT. A plant grown and marketed in a container (See also "Pot in Pot.")

CROWN. The portion of a tree comprising the branches.

EYE. A dormant bud on a corm, tuber, or root division from which a stem will develop when the corm or tuber is planted.

FAN. Descriptive term for the growth habit of certain perennial plants, such as *Iris* and *Hemerocallis*, which have no vertical stem because the leaves originate from the rhizome.

FIELD POTTED. See Balled and Potted.

American Standard for Nursery Stock (ANSI Z60.1-2004)

GRADE. A grade is a classification unit based on a specific size or size range, number of stems or canes, etc. For the purposes of this Standard, grade is not intended to describe quality, except for Roses (see Section 5).

GROW BAG. Also called in-ground fabric bags. An in-ground fabric bag is a porous bag into which liner plants are placed for growing on to landscape size. Root growth through the bag is restricted, resulting in a compact, fibrous root ball within the bag. For purposes of the *American Standard for Nursery Stock*, these are not containers unless used to grow plants above the ground.

GROWTH HABIT. The mode or rate of growth, general shape, mature size, and branching structure of a plant, including the changes which take place seasonally during its life cycle (e.g., deciduous, flowering, fruiting, etc.).

HEIGHT. Unless otherwise specified, the vertical distance between the collar or ground line and the top of the stem, measured in the plant's natural position. Techniques for proper measurement are determined by the particular growth habit of the plant, and may not always extend to the tip of the stem.

MEDIUM. A mixture of two or more ingredients such as soil, peat moss, perlite, ground bark, sand, etc., in which a container plant has been grown.

NURSERY STOCK. Plants grown in or obtained from a nursery.

PLUG. A cylinder of medium in which a plant is grown. The term is generally used to describe seedlings and rooted cuttings that have been removed from the container but with the medium held intact by the roots.

POT IN POT. A method of container-grown nursery production whereby a container is placed into another larger container which has been placed in or on the ground, surrounded by soil or mulching material, to aid in weed control and fertilization processes, maintain a more constant media temperature, and prevent the plant from being blown over by winds.

PROCESSED BALLED PLANT. A plant dug bare root, while dormant, to which a moist growing medium is added around the roots to form a ball designed to sustain plant growth.

ROOT BALL. The intact ball of earth or growing medium containing the roots of a nursery plant.

ROOT COLLAR. See COLLAR.

ROOT FLARE or TRUNK FLARE. The area at the base of the plant's stem or trunk where the stem or trunk broadens to form roots; the area of transition between the root system and the stem or trunk.

ROOT PRUNING. The systematic pruning of roots of nursery plants growing in the field, in order to stimulate branching of roots and the production of fibrous roots.

SPREAD. A term used to indicate the horizontal width of a shrub or the crown of a tree. Techniques for proper measurement are determined by the particular growth habit of the plant, and may not always be the maximum distance between any two branch tips.

American Standard for Nursery Stock (ANSI Z60.1-2004)

UNDERSTOCK, OR ROOTSTOCK. The term used to describe that part of a plant, including the collar and roots, on which another variety has been budded or grafted.

TRUNK. That portion of a stem or stems of a tree before branching occurs.

TRUNK FLARE. See **ROOT FLARE**.

WHIP. A young tree without branches. In some species and grades, spurs may be present.

WHORL. The arrangement of three or more buds, leaves, flowers, or twigs at the same node.

Appendix B: Metric Equivalents

The following table was prepared in cooperation with the Canadian Nursery Trades Association to assist in nursery trade between the U.S. and Canada as well as with other countries using metric.

The following “metric equivalents” are suggested for use in sizing nursery plants:

United States: Metric Equivalents

For plants sized by height or spread		For plants sized by caliper	
U.S. measure	Metric measure	U.S. measure	Metric measure
4 in.	10 cm.	$\frac{1}{16}$ in.	1.6 mm.
6 in.	15 cm.	$\frac{3}{32}$ in.	2.4 mm.
7.5 in.	19 cm.	$\frac{1}{8}$ in.	3.2 mm.
8 in.	20 cm.	$\frac{3}{16}$ in.	4.8 mm.
9 in.	23 cm.	$\frac{1}{4}$ in.	6.3 mm.
10 in.	25 cm.	$\frac{9}{32}$ in.	7.1 mm.
12 in.	30 cm.	$\frac{5}{16}$ in.	8.0 mm.
15 in.	38 cm.	$\frac{3}{8}$ in.	9.5 mm.
18 in.	46 cm.	$\frac{7}{16}$ in.	11.1 mm.
21 in.	53 cm.	$\frac{1}{2}$ in.	12.7 mm.
2 ft.	61 cm.	$\frac{9}{16}$ in.	14.3 mm.
2.5 ft.	76 cm.	$\frac{5}{8}$ in.	16.0 mm.
3 ft.	91 cm.	$\frac{11}{16}$ in.	17.5 mm.
3.5 ft.	1.07 m.	$\frac{3}{4}$ in.	19.0 mm.
4 ft.	1.22 m.	$\frac{7}{8}$ in.	22.0 mm.
4.5 ft.	1.37 m.	1 in.	25.4 mm.
5 ft.	1.52 m.	$1\frac{1}{4}$ in.	32.0 mm.
5.5 ft.	1.68 m.	$1\frac{1}{2}$ in.	38.0 mm.
6 ft.	1.73 m.	$1\frac{3}{4}$ in.	45.0 mm.
7 ft.	2.13 m.	2 in.	50.0 mm.
8 ft.	2.44 m.	$2\frac{1}{2}$ in.	63.0 mm.
9 ft.	2.74 m.	3 in.	76.0 mm.
10 ft.	3.05 m.	$3\frac{1}{2}$ in.	90.0 mm.
12 ft.	3.66 m.	4 in.	100.0 mm.
14 ft.	4.27 m.	$4\frac{1}{2}$ in.	110.0 mm.
16 ft.	4.88 m.	5 in.	130.0 mm.
18 ft.	5.49 m.	$5\frac{1}{2}$ in.	140.0 mm.
20 ft.	6.10 m.	6 in.	150.0 mm.
		7 in.	180.0 mm.
		8 in.	200.0 mm.

APPENDIX C: LETTER OF RECOMMENDATION

Recommendation to Revise American Standard for Nursery Stock (ANSI Z60.1-2004)

HORTICULTURAL STANDARDS COMMITTEE

American Nursery & Landscape Association
1000 Vermont Ave., NW Suite 500
Washington, DC 20005

Phone: 202/789-2900 Fax: 202/789-1893 email: wquinn@anla.org

Name _____ Date: _____

Firm, organization, or subcommittee: _____

Address:

Phone:

Fax:

E-mail:

Section/Paragraph(s):

Subject/Problem:

I recommend that:

Note: Copy this form - do not remove this page from the book. All recommendations must be in writing. Be concise but complete. Reference all appropriate page and paragraph numbers (*American Standard for Nursery Stock*, 2004 edition) unless your recommendation is for a new section. State the problem and provide a possible solution, and provide references to any resources which the Committee should review in making its determination regarding your recommendation. Attach additional pages. You will receive a written response.

THIS SECTION FOR ANLA USE ONLY

Received on _____ By _____

Presented to Committee on _____ Response sent on _____ By _____

Passed on _____ Rejected on _____

Subject for further study _____

Notes: